



























OPHTHALMIC
INSTRUMENTS



INSTRUMENTE GMBH

CONTENTS

	01	Speculums
	08	Rings & Depressors
	09	Retractors
	12	Lacrimal Instruments
	15	B.P. Handles & Blade Breaker
	16	Elevators & Chisels
	17	Knives & Spuds
	18	Punches
	20	Spatulas
	21	Loops & Hooks
	23	Spoons, Curettes & Hooks
	24	Manipulators & Hooks
	29	Choppers
	35	Spatulas
	36	LASIK Instruments
	38	Knives
	40	Fixation Rings
	41	Markers
	43	Scissors
	51	Cannulas
	58	Bimanual I/A
	59	Forceps
	82	Needle Holders
	85	Tonometer & Blades
	86	Sterilizing Trays

Barraquer Wire Speculum

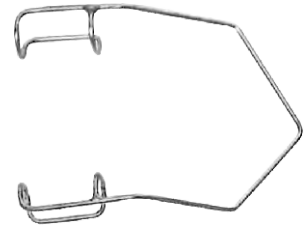

RD-1001 (43101-03)
Small - Blade Length: 10mm

Barraquer Heavy Wire Speculum

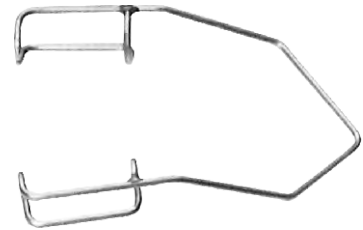

RD-1002 (43101-04)
Adult Size - Blade Length: 14mm

Barraquer Speculum with Solid Blade

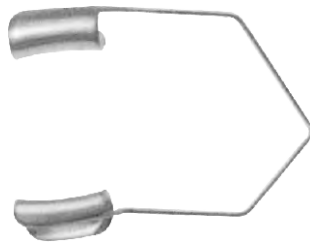

RD-1003
Blade Length: 11mm

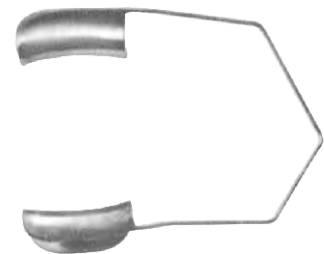

RD-1004
Blade Length: 15mm

Kratz-Barraquer Heavy Wire Speculum with Open Blade

Easy Access to the Cataract Incision
with Phaco or I/A Tip



RD-1005
Small

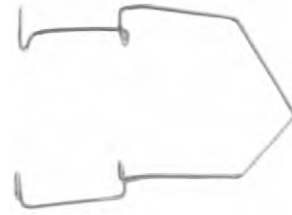

RD-1006
Large

Wire Speculum

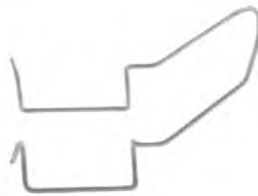

RD-1007
Temporal
Spring toward Nasal Side

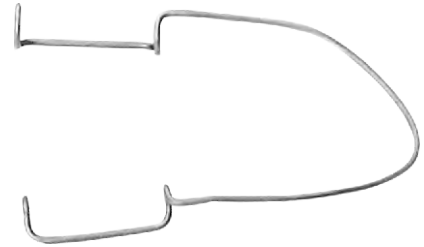

RD-1008
Kratz-Barraquer
Blade Length: 18mm

McIntyre Wire Speculum

Gently curved springs
V-shaped blades

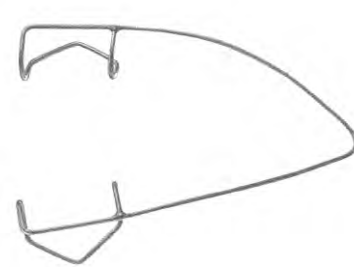

RD-1009
Closed Wire: 13mm Blades

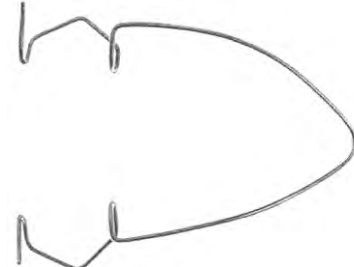

RD-1010
Open Wire: 13mm Blades

Nevyas Wire Speculum Frankel Infant Lid Speculum

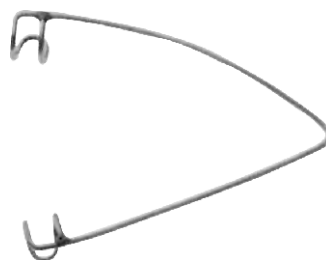

RD-1011
Infant - Blade Length: 4mm

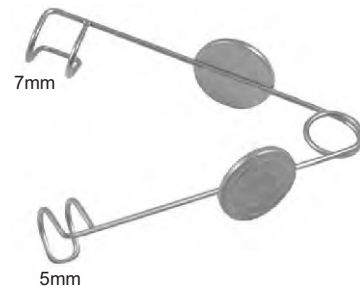

RD-1012
One Blade 5mm, One Blade 7mm

Lieberman Style Wire Speculum

Adjustable Mechanism



RD-1013, RD-1013T
Blades Length: 15mm, K-wire, Standard

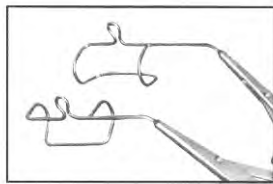

RD-1014, RD-1014T
Blades Length: 15mm
with Traction Suture Anchor Posts

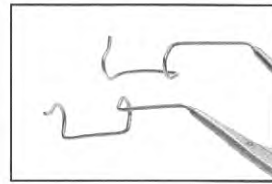

RD-1015, RD-1015T
Blades Length: 10mm, K-wire, Small

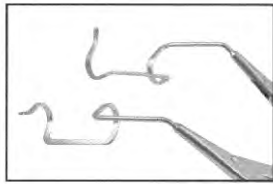

RD-1016, RD-1016T
Blades Length: 15mm, K-wire, Flattened

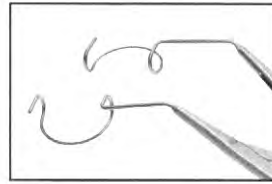

RD-1017, RD-1017T
Blades Length: 11mm, Rounded



RD-1018, RD-1018T
Blades Length: 13mm, Triple Post

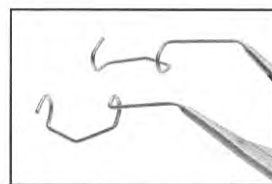

RD-1019, RD-1019T
Blades Length: 15mm, V-shaped

Lieberman Temporal Approach Speculum

Adjustable Mechanism on Nasal Side
Open Wire Blades



RD-1020, RD-1020T
Blades Length: 15mm

Double-X Speculum

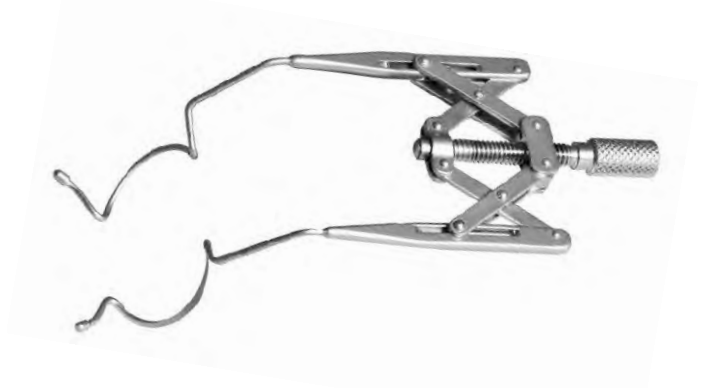

RD-1021
Blade 15mm, K-wire, Small

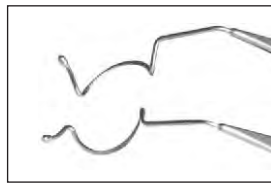

RD-1022
Blade 10mm, K-wire

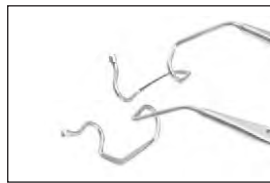

RD-1023
Blade 15mm, V-wire



RD-1024
Blade 15mm, Solid Blades

Castroviejo Eye Speculum



RD-1025 (43132-08)
Blade 14mm, Adjustable Mechanism

Schott Eye Speculum



RD-1026
16mm wire blades

Murdoch Eye Speculum

With Locking Screw



RD-1027 (43115-05)
Blades Length: 12mm



RD-1028
Blades Length: 15mm

Cook Eye Speculum

With Locking Screw



RD-1029
Blades Length: 8mm



RD-1030
Blades Length: 11mm



RD-1031
Blades Length: 15mm

Lancaster Eye Speculum

Adjustable Mechanism
with Locking Nut



RD-1032 (43129-07)
Blades Length: 16mm

Lieberman Eye Speculum



RD-1033, [RD-1033T](#)
Solid Blades, Adjustable

Kraff Eye Speculum



RD-1034, [RD-1034T](#)
Nasal Solid Blades, Adjustable

Slade LASIK Speculum



RD-1035, [RD-1035T](#)
Blade Length: 17mm

Kraff Nasal LASIK Speculum



RD-1036, [RD-1036T](#)
Blade Length: 19mm

Slade Aspirating LASIK Speculum

Used with Suction Set
on Low or Syringe



RD-1037
Blade Length: 17mm

Machat-Buratto Aspirating LASIK Speculum

Used with Suction Set
on Low or Syringe



RD-1038
Blade Length: 15mm

Lieberman Aspirating Speculum

Used with Suction Set
on Low or Syringe



RD-1039
Blade Length: 15mm

Flieringa Scleral Fixation Ring

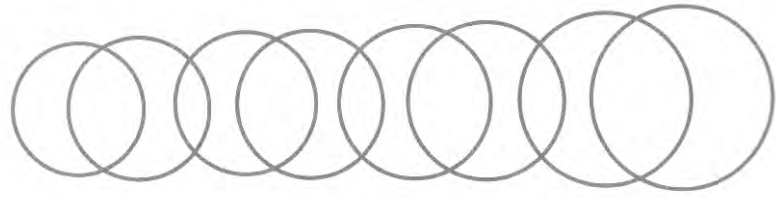

RD-1061
Set of eight: 15mm - 22mm

Schepens Scleral Depressor

7mm Wide Tip



RD-1062
Small Thimble

RD-1063
Medium Thimble

RD-1064
Large Thimble

Schocket Scleral Depressor

Double ended with
Pocket clip



RD-1065

Jaeger Lid Plate



RD-1066 (43150-11)

Stevenson Lacrimal Sac Retractor

Self-Retaining
Adjustable



RD-1081 (43139-07)
3 x 3 Blunt Prongs

Stevenson Lacrimal Sac Retractor

Self-Retaining
Adjustable



RD-1082
Solid Blades with Serrated Edge

Jaffe Lid Retractor



RD-1083
Child, 9mm Blades (Pair)

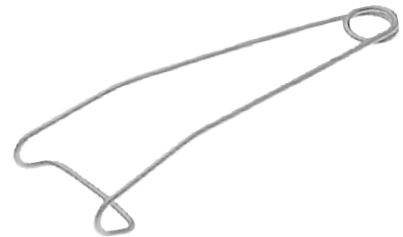

RD-1084
Adult, 14mm Blades (Pair)

Agricola Lacrimal Sac Retractor

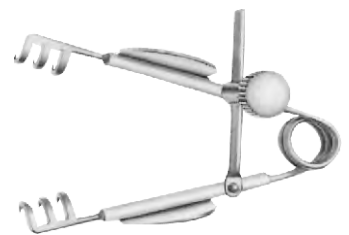

RD-1085
3 x 3 Sharp Prongs

RETRACTORS

Knapp Lacrimal Retractor



RD-1086 (43377-13)
4-Prong, Blunt

RD-1087 (43376-13)
4-Prong, Sharp

Desmarres Lid Retractor



RD-1088 (19230-08)
Size-0, 8mm

RD-1089 (19230-10)
Size-1, 10mm

RD-1090 (19230-12)
Size-2, 12mm

RD-1091 (19230-14)
Size-3, 14mm

Schepens Orbital Retractor



RD-1092

Walton Conjunctiva Retractor



RD-1093, **RD-1093T**
Blade Length: 6mm wide, Solid Thin

Helveston Tissue Retractor

Thin Curved Blade



RD-1094, **RD-1094T**
Blade Length: 7mm wide

RD-1095, **RD-1095T**
Blade Length: 9mm wide

RD-1096, **RD-1096T**
Blade Length: 11mm wide, Concave

Castroviejo Caliper

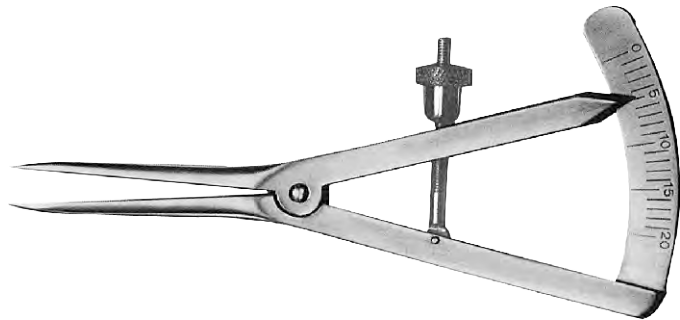

RD-1097, **RD-1097T** (43583-07)
Straight, 20mm Spread

RD-1098, **RD-1098T**
Curved, 20mm Spread

Braunstein Caliper



RD-1099, **RD-1099T**
3.0mm & 3.5mm

RD-1100, **RD-1100T**
3.5mm & 4mm

Wright Fascia Needle



RD-1101
140mm Long, 1mm x 6mm Oval Hole

Bowman Malleable Lacrimal Probe

RD-1121 (43613-00)
Size 0000 & 000

RD-1122 (43614-00)
Size 00 & 0

RD-1123 (43614-12)
Size 1 & 2

RD-1124 (43614-34)
Size 3 & 4

RD-1125 (43614-56)
Size 5 & 6

RD-1126 (43614-78)
Size 7 & 8

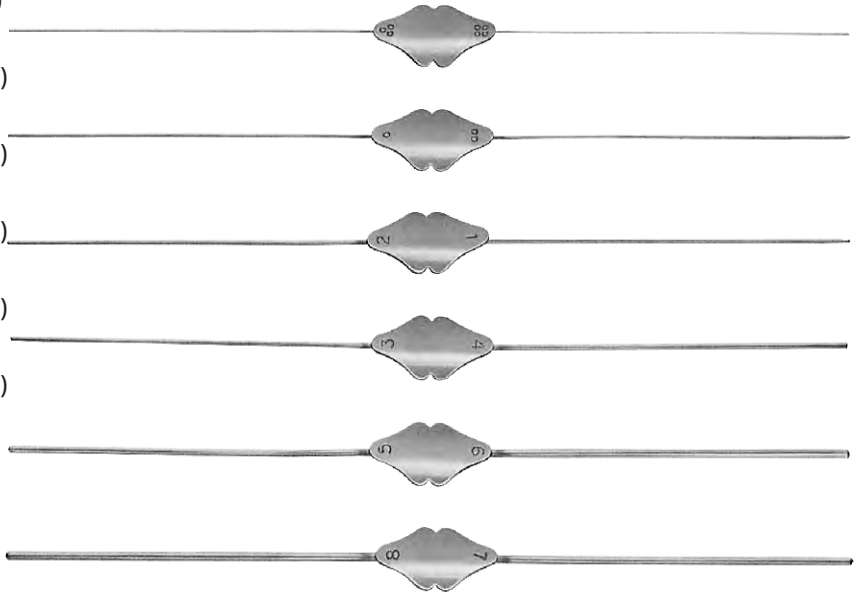

RD-1127
Set of 6 Sizes

Infant Lacrimal Dilator



RD-1128, RD-1128T
Very Fine Blunt Tip

Muldoon Lacrimal Dilator



RD-1129, RD-1129T
Blunt Tip

Wilder Lacrimal Dilator

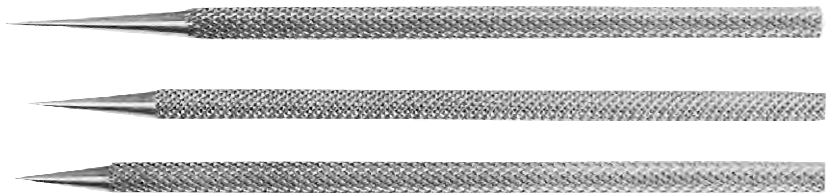

RD-1130, RD-1130T (43602-01)
Size-1, Fine Taper

RD-1131, RD-1131T (43602-02)
Size-2, Medium Taper

RD-1132, RD-1132T (43602-03)
Size-3, Heavy Taper

Castroviejo Lacrimal Dilator



RD-1133 (43608-12)
Double-end fine and medium taper

Pigtail Probe



RD-1134 (43609-17)
With Suture Holes

Harms Trabeculotomy Probe



RD-1135 (43610-01)
With Suture Holes
Left

RD-1136 (43610-02)
With Suture Holes
Right

Crawford Retrieving Hook



RD-1137

Beyer Rongeur



2/3

RD-1138 (33156-18)
Single Action

Nasal Speculum



2/3

RD-1139 (47102-01)
Infant

RD-1140 (47102-02)
Child

RD-1141 (47102-03)
Adult

Joseph Periosteal Elevator



3/4

RD-1142 (33718-16)
Gently Curved Tip

Mallet Lead Filled

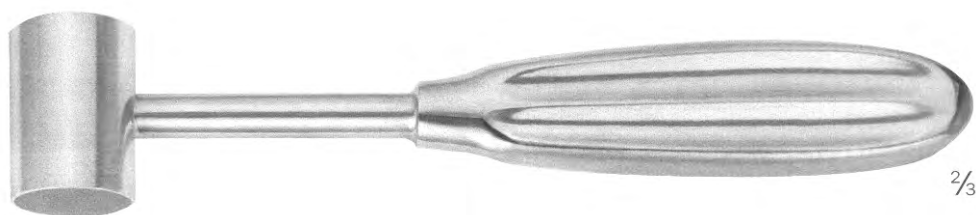

2/3

RD-1143 (33686-25)

Troutman Blade Breaker & Holder

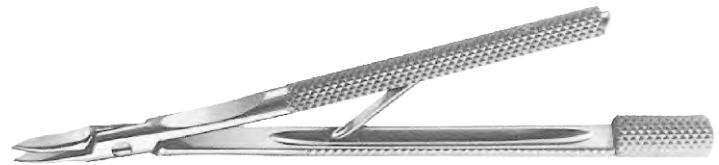

RD-1161, RD-1161T (07290-09)
Small

Castroviejo Blade Breaker & Holder

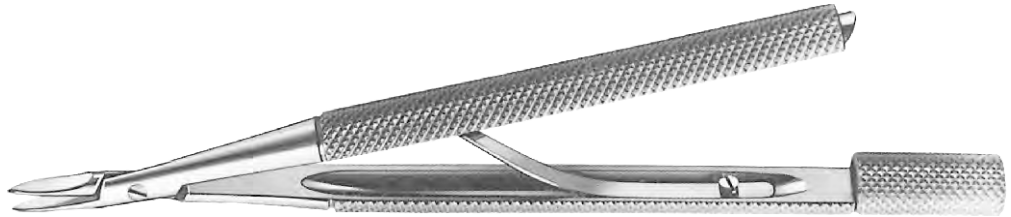

RD-1162, RD-1162T (07294-13)
Large

Scalpel Handles

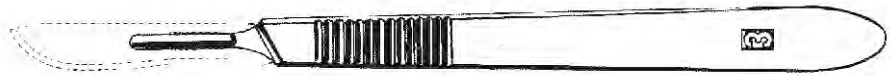

RD-1163 (07103-00)
Suitable for blades

Scalpel Handles



RD-1164 (07107-00)
16.5cm

RD-1165 (07107-01)
12cm

Scalpel Handles



RD-1166 (07109-10)
10cm

RD-1167 (07109-13)
13cm

ELEVATORS & CHISELS

Freer Periosteal Elevator



RD-1181 (47415-18)
One End Blunt & Other End Semi Sharp

Stallard Dissector



RD-1182
Blunt

Rollet Rugine



RD-1183 (43342-12)

West Lacrimal Chisel

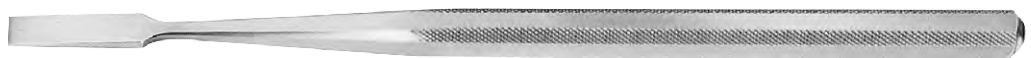

RD-1184 (47486-16)
Straight

Feer Lacrimal Chisel



RD-1185 (47451-04)
Curved

Tooke Corneal Knife



RD-1186 (43228-12)
Straight with Curved Cutting Edge

Corneal Dissector



RD-1187
Straight Blade, Angled

RD-1188
Curved Blade, Angled

Gill Corneal Knife

Curved Cutting Edge



RD-1189 (43231-12)
Straight

RD-1190
Light Curve

DALK Lamellar Dissector



RD-1191
Semi-sharp dissector helps remove the stromal fibers

Fukasaku "Hockey" Knife



RD-1192
Sharp 3mm Front Edge, Semi-sharp 6mm Bottom Edge

Foreign Body Spud



RD-1193 Golf Club (43327-11)
Angled, Lightly Round Tip

RD-1194 Francis (43321-12)
Angled, Flag Shaped Tip

RD-1195 Ellis (43331-11)
Lightly Curved, Round Tip

Spud & Gouge

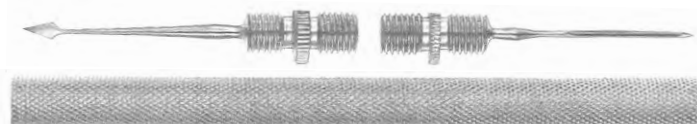

RD-1196 (43546-13)
Reversible Handle

Kelly Membrane Punch

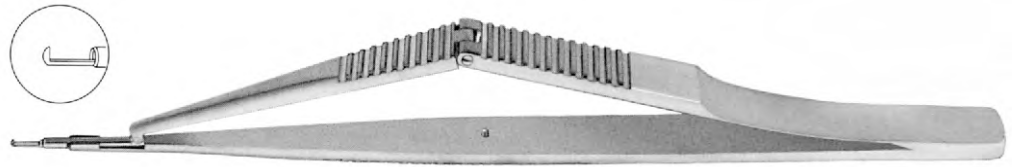

RD-1201, RD-1201T
0.8mm Dia. Tip

Gass Corneoscleral Punch

Rotatable for
Convenient Positioning



RD-1202
1.5mm Dia. Tip

Fukasaku Micro Trabeculectomy Punch

Bullet Shaped Tip
0.3mm x 0.6mm Deep Bite



RD-1203T
0.6mm Dia. Head

Kerrison Rongeur

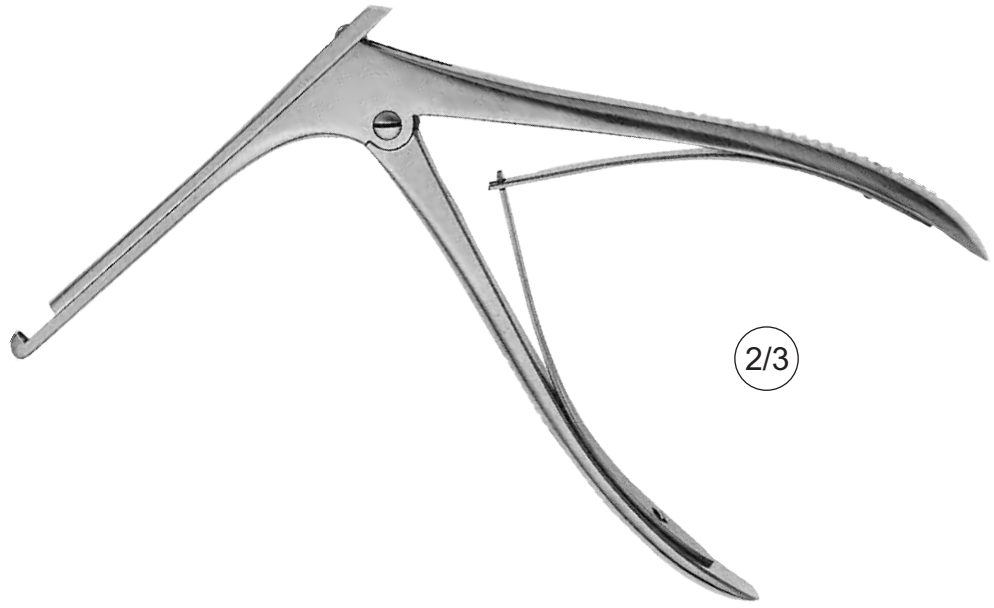

RD-1204 (47303-03)
Size-1, 3.0mm Wide

RD-1205 (47303-04)
Size-2, 4.0mm Wide

Citelli Rongeur

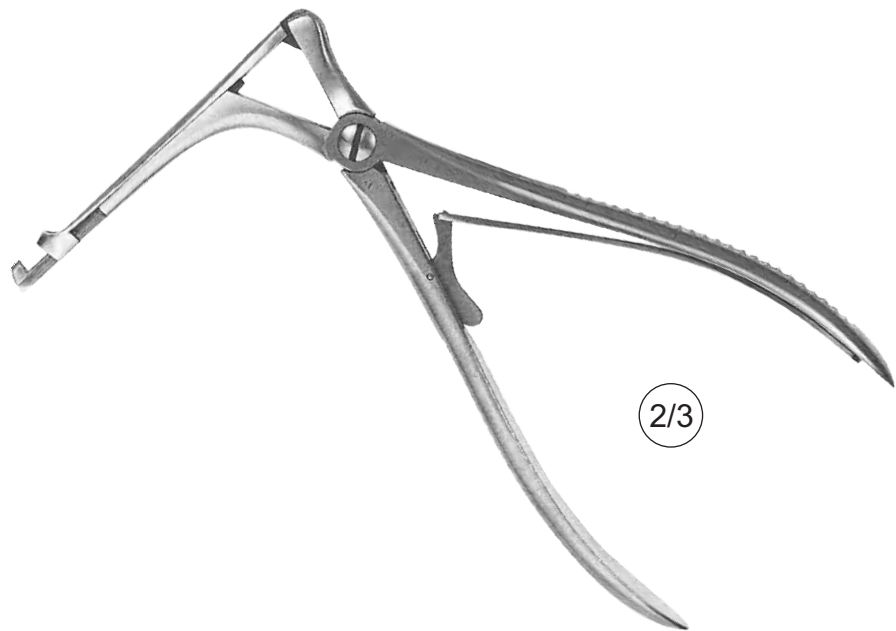

RD-1206 (47304-02)
Size-2, 3.0mm Wide

SPATULAS

McPherson Iris Spatula



RD-1221
Malleable, 1mm Wide

Culler Iris Spatula

Malleable Blades

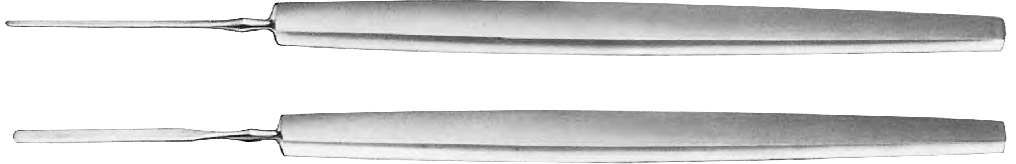

RD-1222
Malleable, 1mm Wide

RD-1223
Malleable, 2mm Wide

Wheeler Double Ended Spatula



RD-1224 (43523-12)
Lightly Curved

Elschnig Cyclodialysis Spatula



RD-1225 (43515-14)
Tip Width: 1mm

Barraquer Iris Spatula



RD-1226
Tip Width 0.50mm
Round, Smooth

RD-1227
Tip Width 0.25mm
Round, Smooth

Castroviejo Synechiaie Spatula



RD-1241 (43525-05)
Double Ended, Semi-Sharp Tips, Tip Width: 0.50mm

Lewis & SNELLEN Lens Loop



RD-1243
Small

RD-1244
Large

RD-1245 (43443-13)
Serrated

Kirby Lens Loop



RD-1246
Lens Loop and Muscle Hook

Gass Retinal Detachment Hook



RD-1247 (43391-13)
With oval hole

Stevens Tenotomy Hook



RD-1248
Small, Blunt

Graefe Muscle Hook



RD-1249 (43351-01)
Size-1

RD-1250 (43351-02)
Size-2

RD-1251 (43351-03)
Size-3

Jameson Muscle Hook

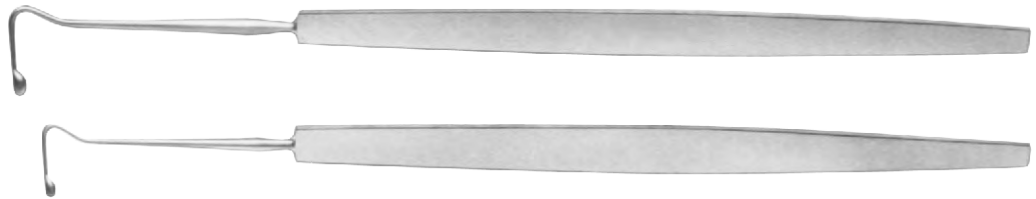

RD-1252
Small

RD-1253 (43353-13)
Large

Green Muscle Hook



RD-1254 (43355-13)

Fixation Hook



RD-1255 (19212-01)
Double, Sharp, Small

RD-1256 (19212-02)
Double, Sharp, Large

Meyerhoefer Chalazion Curette

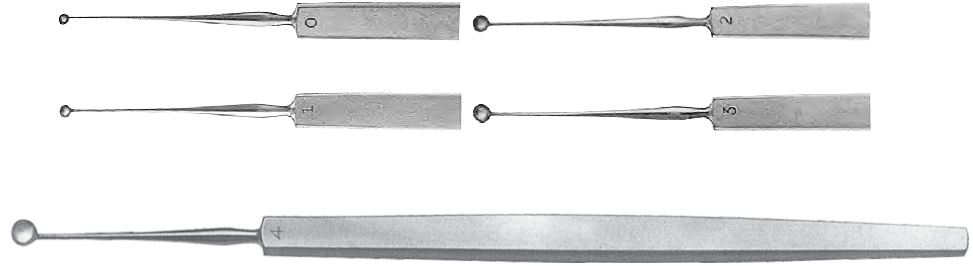

RD-1266 (43402-15)

Size-0
1.50mm Dia.

RD-1267 (43402-18)

Size-1
1.75mm Dia.

RD-1268 (43402-20)

Size-2
2.0mm Dia.

RD-1269 (43402-25)

Size-3
2.50mm Dia.

RD-1270 (43402-35)

Size-4
3.50mm Dia.

Culler Lens Spoon



RD-1271
Sterling Silver

Bunge Evisceration Spoon



RD-1272 (43420-01)
Small

RD-1273 (43420-03)
Large

Wells Enucleation Spoon



RD-1274 (43482-20)

Bonn Micro Iris Hook

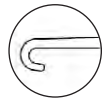

RD-1281, [RD-1281T](#)

Tip Width: 0.55mm, Very Delicate, Straight Blunt Tip

Hirshman Iris Hook



RD-1282, [RD-1282T](#)

Blunt, Angled

Sinskey II IOL Manipulating Hook

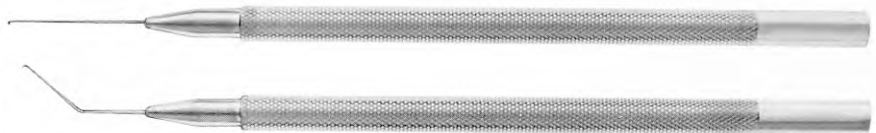

RD-1283, [RD-1283T](#) (43388-02)

Straight with Round Handle
0.2mm Dia. Blunt Tip

RD-1284, [RD-1284T](#) (43389-02)

Angled with Round Handle
0.2mm Dia. Blunt Tip

Jaffe Lens Manipulating Hook



RD-1285, [RD-1285T](#)

Straight with Flat Handle
0.15mm Dia. Blunt Tip

RD-1286, [RD-1286T](#)

Angled with Flat Handle
0.15mm Dia. Blunt Tip

Lewicky IOL Manipulating Hook



RD-1287, [RD-1287T](#)

Angled, 0.15mm Dia. Blunt Tip

Rentsch IOL Manipulating & Iris Hook

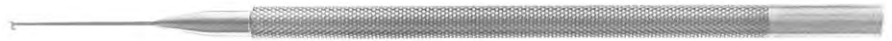

RD-1288, [RD-1288T](#)
Angled

Kuglen Iris Hook & Lens Manipulator

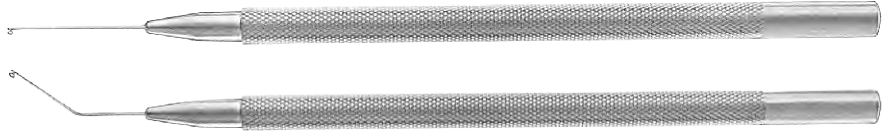

RD-1289, [RD-1289T](#)
Straight, Push-Pull Model

RD-1290, [RD-1290T](#)
Angled, Push-Pull Model

Kuglen Iris Hook & Manipulator



RD-1291, [RD-1291T](#) (43390-05)
Straight

Fenzl Lens Manipulating Hook

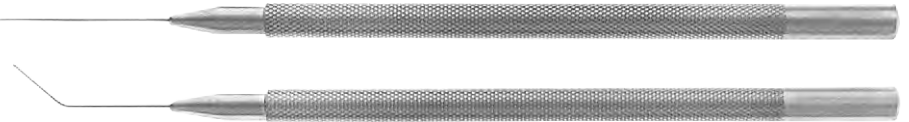

RD-1292, [RD-1292T](#)
Straight, 0.15mm Dia. T-Shaped Tip

RD-1293, [RD-1293T](#)
Angled, 0.15mm Dia. T-Shaped Tip

Maltzman-Fenzl Lens Manipulating Hook



RD-1294, [RD-1294T](#)
Angled, 0.15mm Dia. V-Shaped Tip

Jaffe-Maltzman Lens Manipulating Hook



RD-1295, [RD-1295T](#)
Angled, 0.15mm Dia. V-Shaped Tip, Flat Handle

Bechert Nucleus Rotator

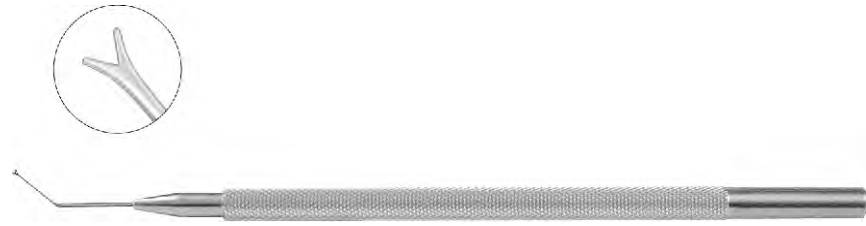

RD-1296, [RD-1296T](#)
Angled 7mm, Blunt tip

RD-1297, [RD-1297T](#)
Angled 9mm, Blunt tip

Clayman Nucleus Rotator



RD-1298, [RD-1298T](#)
0.5mm wide flat spatula
with v-notched tip

Lester IOL Manipulator

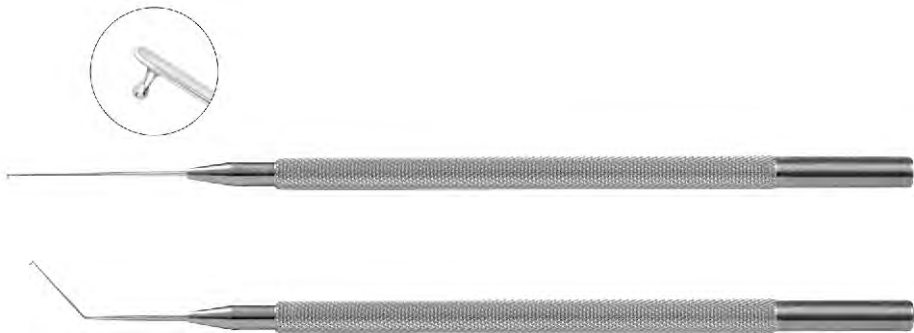

RD-1299, [RD-1299T](#)
0.25mm dia. tip, straight

RD-1300, [RD-1300T](#)
0.25mm dia. tip, angled

Jaffe IOL Spatula



RD-1301, [RD-1301T](#)
Angle to Tip: 10mm, Tip Width: 0.50mm, Flat Smooth Tip

Escaf Nucleus Manipulator

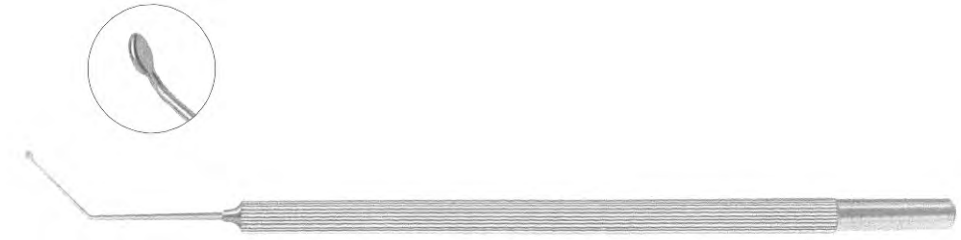

RD-1302, RD-1302T
50° Angled, Flattened Tip

Knolle Nucleus Spatula



RD-1303, RD-1303T
0.5mm Wide, Flat

Koch Nucleus Spatula

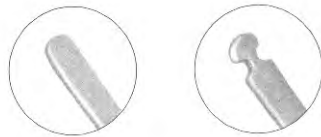

RD-1304, RD-1304T
Gently Curved, Smooth

RD-1305, RD-1305T
Gently Curved, Notches

Escaf Nucleus Sustainer



RD-1306, RD-1306T
Smooth Ball Tip

Graether Collar Button Micro Iris Retractor



RD-1307, RD-1307T
Straight

RD-1308, RD-1308T
Angled

Lieberman MicroFinger & Spatula



RD-1309, RD-1309T

Lieberman MicroFinger and Spatula

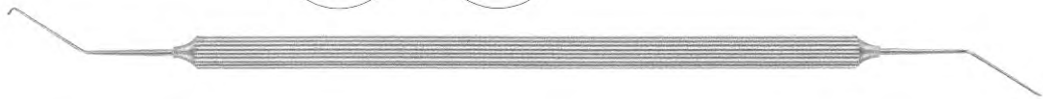
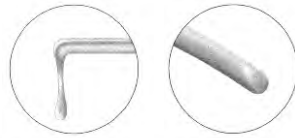

RD-1310, RD-1310T
For Use in Right Hand

RD-1311, RD-1311T
For Use in Left Hand

Fukasaku-Lieberman Phaco Spatula

Small pupil snapper hook and the MicroFinger

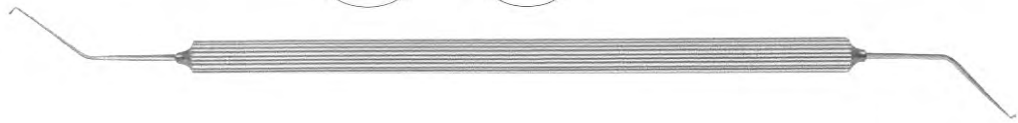
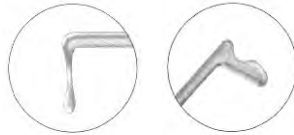

RD-1312, RD-1312T
For Use in Right Hand

RD-1313, RD-1313T
For Use in Left Hand

Grayson Nucleus Manipulator



RD-1314, RD-1314T
1.1mm Long Tip, Flattened

Drysdale Nucleus Manipulator

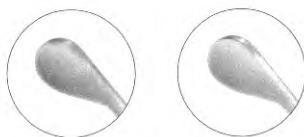

RD-1315, RD-1315T
Rounded Edges

RD-1316, RD-1316T
Defined Interior Edge

CHOPPERS

Tennant Nucleus Manipulator



RD-1341, [RD-1341T](#)
Tip Dia. 0.6mm, To Split and Rotate Nucleus

Nagahara Phaco Chopper



RD-1342, [RD-1342T](#)
Cutting Edge 90°, Cutting Length: 1.5mm

Nagahara Phaco Chopper



RD-1343, [RD-1343T](#)
Cutting Edge 60°, Cutting Length: 1.5mm

Koch-Nagahara Spatula & Chopper



RD-1344, [RD-1344T](#)
Cutting Edge 60°, Cutting Length: 1.5mm

Kammann Prechopper



RD-1345, [RD-1345T](#)
Angled, Cutting Edge 2.2mm

RD-1346, [RD-1346T](#)
Straight, Cutting Edge 2.2mm

Friedman-Koch Universal Chopper & Spatula



RD-1347, [RD-1347T](#)
 Double Cutting Edges
 Cutting Edge (Chopper): 1.5mm, Tip Width (Manipulator): 0.8mm

Olson Phaco Chopper

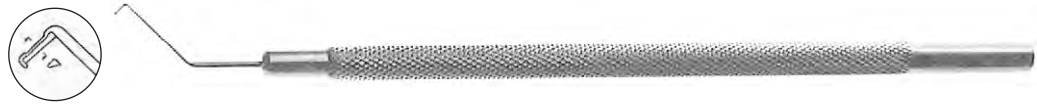

RD-1348, [RD-1348T](#)
 Cutting Edge 60°, Cutting Length: 2mm

Rosen Phaco Splitter



RD-1349, [RD-1349T](#)
 Wedge Shaped

Nordan Capsule Elevator



RD-1350, [RD-1350T](#)
 Tip Dia. 1.5mm

Nagahara Bi-Manual Irrigating Chopper



[RD-1351T](#)
 Round Tip, 20 Gauge Tube

Nagahara Bi-Manual Irrigating Carate Chopper



[RD-1352T](#)
 Sharp Tip, 20 Gauge Tube

CHOPPERS

MICS Phaco Pre-Chopper

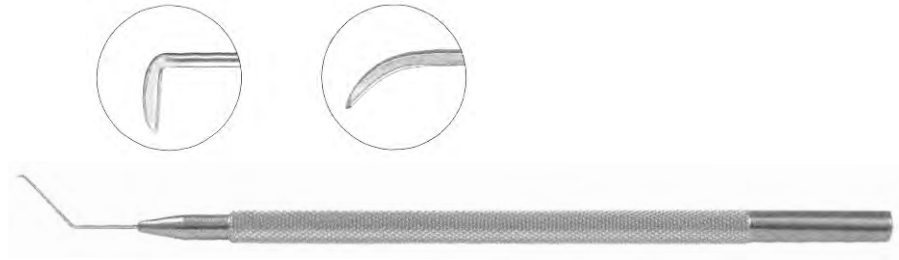

RD-1353, [RD-1353T](#)
Two Defined Edges

RD-1354, [RD-1354T](#)
Curved with Blunt Tip
and Sharp Inferior Edge

Phaco Chopper



RD-1355, [RD-1355T](#)
Ball Tip, 0.7mm Inferior Wedge

Nagahara Phaco Chopper

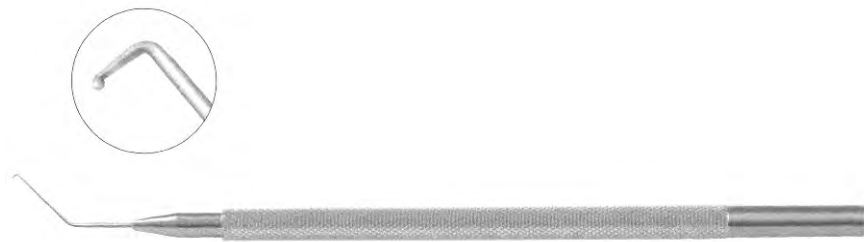

RD-1356, [RD-1356T](#)
Rounded, Blunt Tip, 0.9mm Inferior Wedge

Chang-Seibel Phaco Chopper

A combination of chopper with the Chang MicroFinger and end the Seibel Vertical Safety Chopper

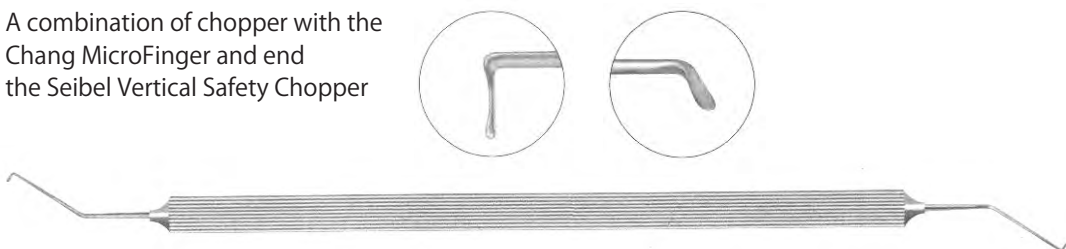

RD-1357, [RD-1357T](#)
For Use in Right Hand

RD-1358, [RD-1358T](#)
For Use in Left Hand

■ Stainless Steel ■ Titanium

Milder Phaco Chopper

60° offset inferior wedge
for horizontal chopping and a
beveled distal tip for vertical chopping

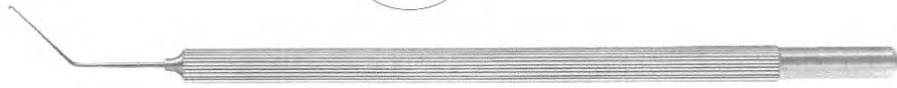

RD-1359, RD-1359T
For Use in Left Hand

Milder Phaco Chopper

60° offset inferior wedge
for horizontal chopping and a
beveled distal tip for vertical chopping
12mm long spatula with disc-shaped tip

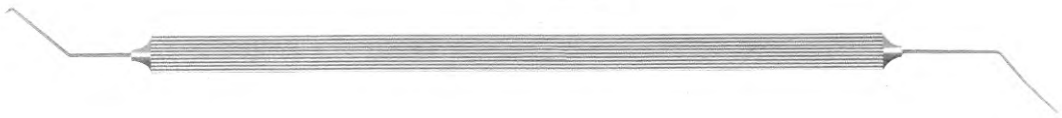

RD-1360, RD-1360T
For Use in Right Hand

RD-1361, RD-1361T
For Use in Left Hand

Masket Phaco Spatula

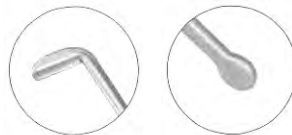

RD-1362, RD-1362T
12mm Long Round Spatula, Disk-shaped Tip

Chang Phaco Chopper

0.9mm Long Quick Chop Tip

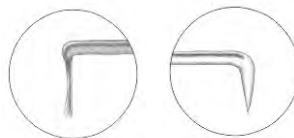

RD-1363, RD-1363T
For Use in Right Hand

RD-1364, RD-1364T
For Use in Left Hand

CHOPPERS

Minardi Phaco Chopper



RD-1365, [RD-1365T](#)
0.7mm Long Quick Chop Tip

Hwang Phaco Chopper

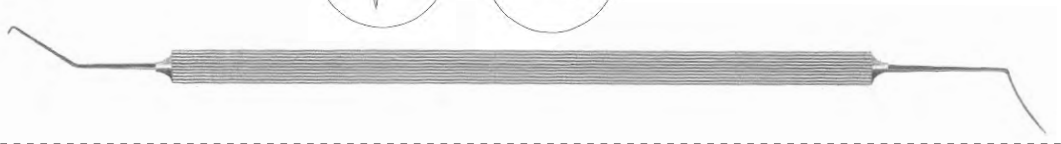
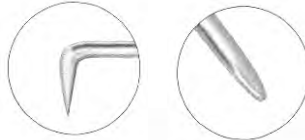

RD-1366, [RD-1366T](#)
1mm Long Vertical Chopper and a Chisel Tipped Spatula

Agarwal Karate Phaco Chopper



RD-1367, [RD-1367T](#)
Semi Sharp, Pointed Tip

Chang MicroFinger Chopper



RD-1368, [RD-1368T](#)
Curved Finger Shaped Tip

Warren Canine Phaco Chopper

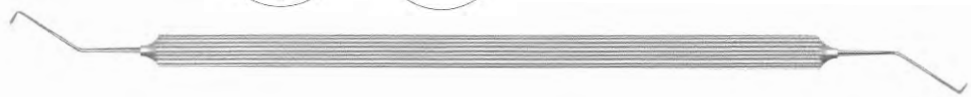
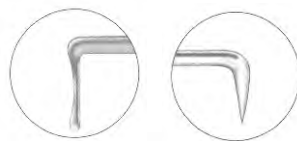

RD-1369, [RD-1369T](#)
2mm Pointed Tip, 3.5mm Long MicroFinger

■ Stainless Steel ■ Titanium

Brierley Nucleus Splitter

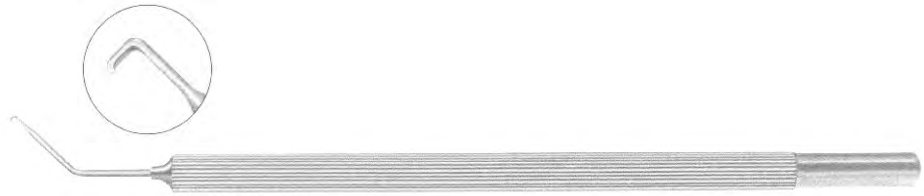

RD-1370, [RD-1370T](#)
Incision Sealing Shaft

Dodick-Kammann Nucleus Chopper

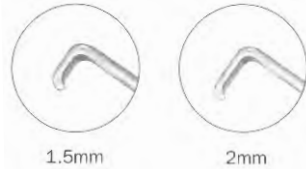

1.5mm

2mm

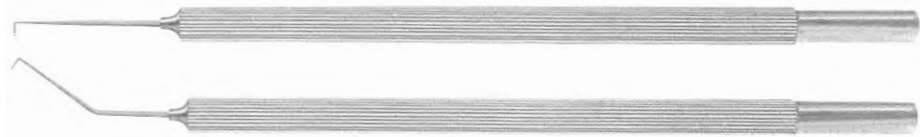

RD-1371, [RD-1371T](#)

1.5mm Long Tip, Straight

RD-1372, [RD-1372T](#)

1.5mm Long Tip, Angled

RD-1373, [RD-1373T](#)

2mm Long Tip, Straight

RD-1374, [RD-1374T](#)

2mm Long Tip, Angled

Koch Nucleus Chopper



RD-1375, [RD-1375T](#)

1.6mm Long Blunted Tip

Escaf Nucleus Divider



RD-1376, [RD-1376T](#)

1.25mm Long Wedge Shaped Tip

Neuhann Nucleus Divider



RD-1377, [RD-1377T](#)

Strongly Curved Spatulated Tip

DALK Corneal Dissector

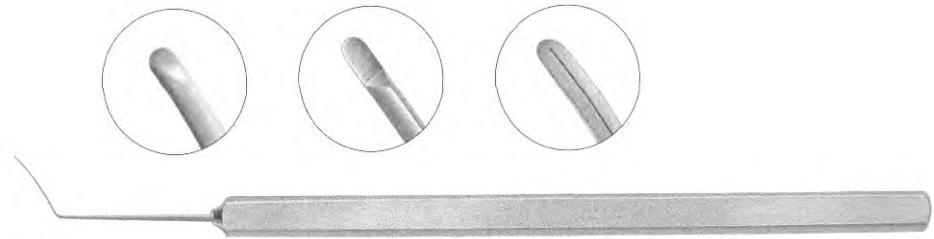

RD-1391, RD-1391T
Flat, 12mm Long, Beveled

RD-1392, RD-1392T
Triangular Shaft

RD-1393, RD-1393T
1mm Wide, 8mm Long, Flattened

Gimbel Nucleus Spatula



RD-1394, RD-1394T
0.25mm Dia., Smooth Angled 30°

Girard Synechia Spatula



RD-1395, RD-1395T
0.5mm Wide Tip, Semi Sharp

Obstbaum Synechia Spatula



RD-1396, RD-1396T
0.25mm Wide Tip, Semi Sharp

Benedetto IntraLase Spatula



RD-1397, RD-1397T
10mm Long, Flattened with Beveled Notches

Moran LASIK Enhancement Spatula

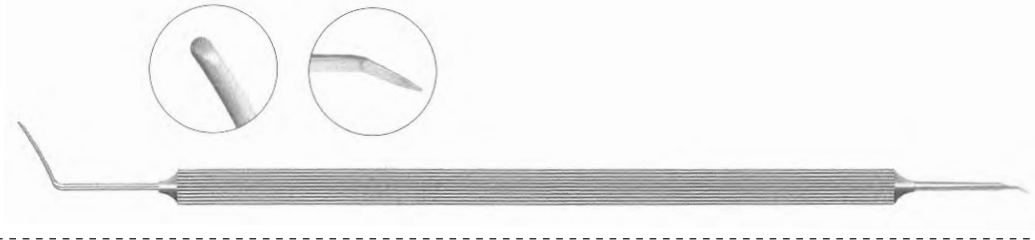

RD-1398, [RD-1398T](#)
A Modified Paton Spatula

Hersh IntraLase Flap Spatula

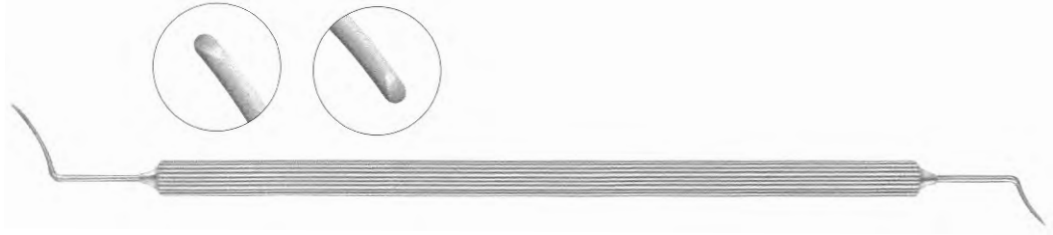

RD-1399, [RD-1399T](#)
6mm & 10mm, Beveled Tips

Binder IntraLase Flap Elevator



RD-1400, [RD-1400T](#)
1mm Wide, 10mm Long, Semi-sharp Edges

Fukasaku LASIK Spatula



RD-1401, [RD-1401T](#)
Rounded Interior, Beveled Edges

Guimaraes LASIK Spatula



RD-1402, [RD-1402T](#)
Gently Curved, Bi-convex, Semi-sharp Edges

Katzen LASIK Flap "Unzipper"

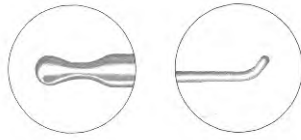

RD-1403, RD-1403T
Bi-convex Spatula with Beveled Notches

Maddox LASIK Spatula



RD-1404, RD-1404T
Flat & Cylindrical Spatula

Rowen Combination LASIK Spatula



RD-1405, RD-1405T

Endothelial Stripper

1mm Wide, Thin Beveled Tip

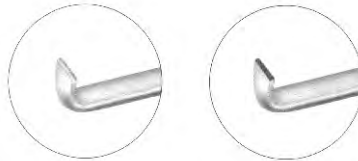

RD-1406, RD-1406T
Smooth Surface

RD-1407, RD-1407T
Textured Surface

Thorlakson Z-LASIK Flap Lifter

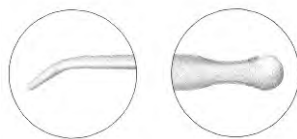

RD-1408, RD-1408T
Beveled Notches, Long Handle

RD-1409, RD-1409T
Beveled Notches, Short Handle

Diamond Knives

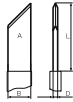
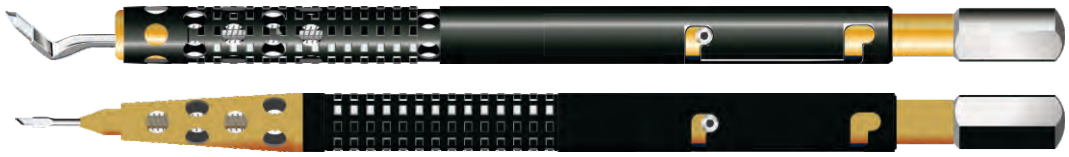

RD-1410T

Straight / Single Edge

FH-MM 6, 0x1, 0x0, 17mm / 30°

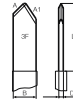

RD-1411T

Tri-facet

FH-MDS 5, 1x1, 0x0, 20mm / 45° / 30°

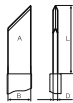

RD-1412T

Straight / Single Edge

FH-MM 4, 0x0, 7x0, 17mm / 45°

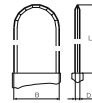

RD-1413T

Tunnel

FH-RS 19-facets 6, 0x2, 0x0, 17mm abg

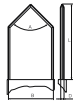

RD-1414T

Clear Cornea MICS

FH-CC 6, 0x2, 2x0, 20mm / 90° abg

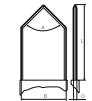

RD-1415T

Clear Cornea 90°

FH-CC 6, 0x3, 0x0, 20mm / 90° abg

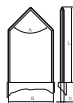

RD-1416T

Tapered Spear MICS

FH-CC tr 6, 0x2, 4/2, 70x0, 20mm / 90° abg

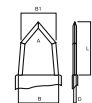

RD-1417T

Clear Cornea 60°

FH-ZALDIVAR 6, 5x0, 55/1, 0x0, 17mm abg

3D Diamond Knives



RD-1418T

FH-CC 3D 6, 0x2, 20x0, 17mm / 80° abg



RD-1419T

FH-CC 3D 6, 0x2, 40x0, 20mm / 80° abg



RD-1420T

FH-CC 3D 6, 0x2, 50x0, 20mm / 80° abg



RD-1421T

FH-CC 3D 6, 0x2, 65x0, 17mm / 80° abg

Diamond Knife with Glaucoma Surgery

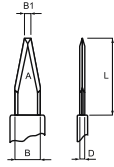

RD-1422T

Step Knife

Steps 0.15 / 0.2 / 0.25 / 0.3 / 0.37 / 0.5 / 4.0
ST-3 Schnitt 6, 0x1, 0x0, 20mm / 25°

Diamond Knife with LRI Surgery

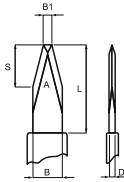

RD-1423T

With 3 Settings: 0.5, 0.55, 0.6

ST-3 Schnitt 5, 1x0, 4/1, 0x0, 10mm / 20°

Step Diamond Knife

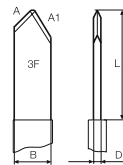

RD-1424T

Tri-facet

Steps at 0/0.3/0.4/0.5/0.6/0.8/1.0/2.5 mm
ST-3 MDS 5, 6x1, 0x0, 17mm

Hofmann-Thornton Globe Fixation Ring



RD-1431, [RD-1431T](#)
13mm Dia. Multiple Blunt Teeth

RD-1432, [RD-1432T](#)
16mm Dia. Multiple Blunt Teeth

Fine-Thornton Swivel Fixation Ring



RD-1433, [RD-1433T](#)
13mm Dia. Blunt Teeth

RD-1434, [RD-1434T](#)
16mm Dia. Blunt Teeth

Gimbel Stabilizing Ring



RD-1435, [RD-1435T](#)
13mm Dia., Blunt Teeth on Both Sides

Thornton Globe Fixation Ring



RD-1436, [RD-1436T](#)
16mm Dia. Multiple Blunt Teeth

Lu-Mendez LRI Guide and Fixation Rings



RD-1437, [RD-1437T](#)
Delicate Blunt Teeth, Marks 10° Increments, 11mm I.D.

Mendez Degree Gauge



RD-1438, [RD-1438T](#)
12mm I.D. Marked in 10° Increments

Bores Axis Marker



RD-1439, RD-1439T

Camellin Style LASEK Alcohol Well



RD-1440, RD-1440T
8.5mm Dia.

RD-1441, RD-1441T
9.5mm Dia.

McDonald Optic Zone Marker



RD-1442, RD-1442T
6.5mm & 7mm Dia., Double End, Cross Hairs

Anis Radial Marker



RD-1443, RD-1443T
4mm Dia. 8 Blades

RD-1444, RD-1444T
4mm Dia. 12 Blades

RD-1445, RD-1445T
4mm Dia. 16 Blades

Toric Marker



RD-1446, RD-1446T
Half-ring for mark of meridian 12 mm

Intra-Op Toric Axis Marker



RD-1447T
Markings every 5 Degrees

Kellen Capsulorhexis Marker



RD-1448, RD-1448T
6mm Dia.

RD-1449, RD-1449T
5.5mm Dia.

Osher Neuman Corneal Marker



RD-1450, RD-1450T
4 Blades

RD-1451, RD-1451T
6 Blades

RD-1452, RD-1452T
8 Blades

RD-1453, RD-1453T
16 Blades

Hoffer Corneal Optical Zone Markers

Fine Cross Hairs



⊕ RD-1454, RD-1454T
3.0mm

⊕ RD-1455, RD-1455T
3.5mm

⊕ RD-1456, RD-1456T
4.0mm

⊕ RD-1457, RD-1457T
4.5mm

⊕ RD-1458, RD-1458T
5.0mm

⊕ RD-1459, RD-1459T
5.5mm

⊕ RD-1460, RD-1460T
6.0mm

⊕ RD-1461, RD-1461T
6.5mm

⊕ RD-1462, RD-1462T
7.0mm

⊕ RD-1463, RD-1463T
7.5mm

⊕ RD-1464, RD-1464T
8.0mm

Maloney Intra-Operative Keratometer



RD-1465, RD-1465T
Measurement of Astigmatism

SCISSORS

Iris Scissors



RD-1469 (09340-10)
Straight, Delicate, Pointed Tips 10cm

RD-1470 (09341-10)
Curved, Delicate, Pointed Tips 10cm

Iris Scissors

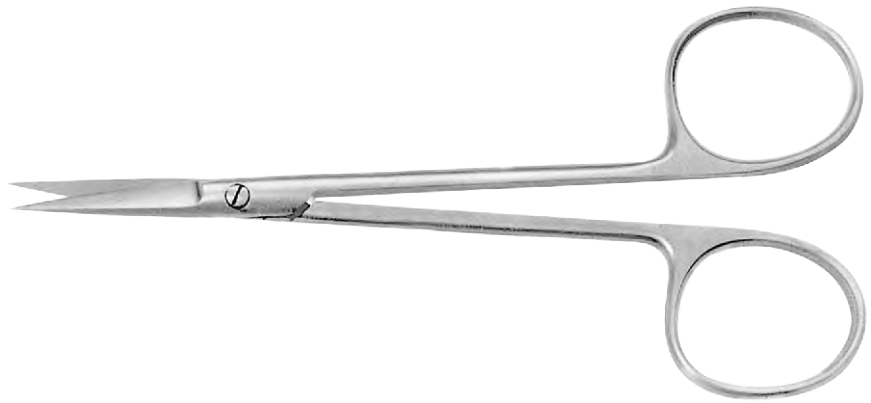

RD-1471 (09340-11)
Straight, Standard, Pointed Tips 11cm

RD-1472 (09341-11)
Curved, Standard, Pointed Tips 11cm

Stevens Tenotomy Scissors

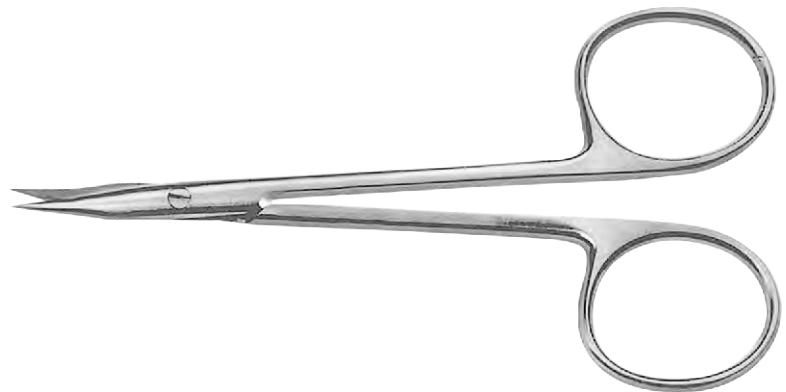

RD-1473 (09361-11)
Needle Points, Lightly Curved

SCISSORS

Stitch Scissors

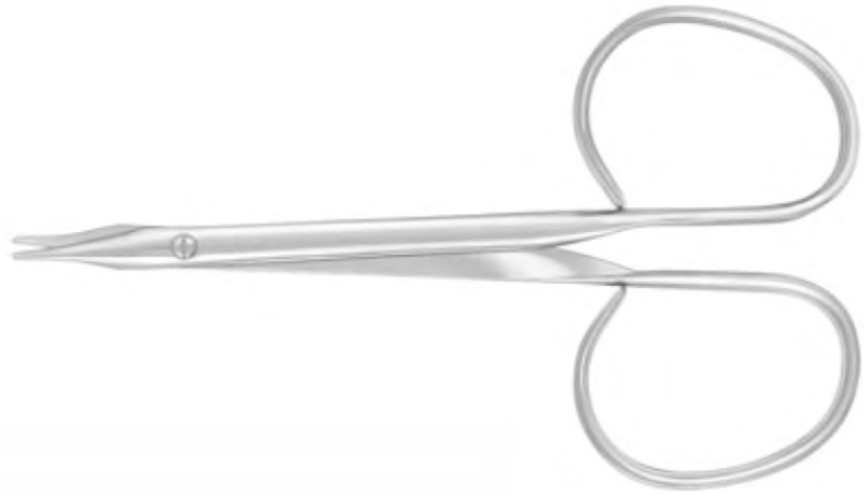

RD-1474 (09351-09)
Ribbon type, Blunt Tips, Straight

RD-1475
Ribbon type, Blunt Tips, Curved

Knapp Strabismus Scissors



RD-1476 (09348-05)
Straight, Blunt Tips 11cm

RD-1477 (09348-06)
Curved, Blunt Tips 11cm

Enucleation Scissors



RD-1478
Blunt tips, Medium Curve
14.5cm Long

RD-1479
Blunt tips, Strong Curve
14.5cm Long

■ Stainless Steel ■ Titanium

SCISSORS

Westcott Tenotomy Scissors



RD-1480 (10104-11)
Blunt

RD-1481 (10102-11)
Pointed

Noyes Scissors



RD-1482 (10110-12)
Straight

Barraquer Iris Scissors



RD-1483 (10119-10)
Blunt tips, 7mm long blades

Castroviejo Keratoplasty Scissors



RD-1484
Angle to Side: Blunt Tip

SCISSORS

Westcott Type Scissors



RD-1485T

Straight, Blade Length 6mm
Flat Titanium Handle Double Action
Stainless Steel Tips

RD-1486T

Curved, Blade Length 6mm
Flat Titanium Handle Double Action
Stainless Steel Tips

McPherson-Westcott Conjunctival Scissors



RD-1487

Blunt tips. Small blades, Curved

Jaffe Stitch Scissors



RD-1488

Very sharp pointed tips, Medium blades, Curved

Westcott Tenotomy Scissors



RD-1489

Blunt tips, Medium blades, Curved

Iris Scissors



RD-1490

Sharp tip, Small blades, Straight

RD-1491

Sharp tip, Small blades, Curved

Fine Stitch Scissors



RD-1492
Sharp tips, Medium blades
Straight

RD-1493
Sharp tips, Medium blades
Curved

Castroviejo Universal Corneal Scissors



RD-1494
Curved, Blunt Tip
Small blades

RD-1495
Curved, Blunt Tip
Medium blades

RD-1496
Curved, Blunt Tip
Large blades

RD-1497
Strongly Curved, Blunt Tip
Large blades

Troutman-Castroviejo Corneoscleral Scissors



RD-1498
With stop, Small blades, Right

RD-1499
With stop, Small blades, Left

Katzin Corneal Transplant Scissors



RD-1500
Strong curve, Medium blades
Right

RD-1501
Strong curve, Medium blades
Left

Castroviejo Corneoscleral Scissors



RD-1502
Small blades, Right

RD-1503
Small blades, Left

Rich Corneal Transplant Scissors

Extremely Delicate
Strongly Curved Blades



RD-1504
Right

RD-1505
Left

Terry Micro Corneal Scissors

Round Handle



RD-1506
Right

RD-1507
Left

Tibolt Punctal Scissors



RD-1508
One conically shaped blade with grooves
and textured surface

DALK Micro Scissors Left + Right Set



RD-1509
The lower blade of the scissors is thinner
and 1mm longer than the upper blade

Vannas Capsulotomy Scissors



RD-1510



RD-1511



RD-1512



RD-1513



RD-1514

RD-1510, [RD-1510T](#) (10140-11)
Straight, Blade Length: 7mm

RD-1511, [RD-1511T](#) (10141-08)
Curved, Blade Length: 7mm

RD-1512, [RD-1512T](#) (10143-08)
Angled-Forward, Blade Length: 7mm

RD-1513, [RD-1513T](#) (10142-08)
Angle to Side, Blade Length: 7mm

McPherson Vannas
RD-1514, [RD-1514T](#)
Sharp Tips, Blade Length: 8mm

Capsulotomy Scissors



RD-1515



RD-1516



RD-1517



RD-1518



RD-1519



RD-1520



RD-1521



RD-1522



RD-1523

7mm extra thin long blades, Sharp tips
RD-1515, [RD-1515T](#)

Vannas Scissors, Straight

RD-1516, [RD-1516T](#)
Vannas Scissors, Curved

RD-1517, [RD-1517T](#)
Gills-Vannas, Angled forward

10mm extra thin long blades, Sharp tips
RD-1518, [RD-1518T](#)
Vannas Scissors, Straight

RD-1519, [RD-1519T](#)
Vannas Scissors, Curved

RD-1520, [RD-1520T](#)
Stern-Gills, Angled forward

RD-1521, [RD-1521T](#)
Uribe-Stern, Curved, Angled forward

10mm long angled blades, Curved tips
RD-1522, [RD-1522T](#)
Gills, Sharp points

RD-1523, [RD-1523T](#)
Uthoff-Gills, Blunt points

Vitreo-Retinal Scissors



Angled 45°



RD-1524T
20 Gauge

RD-1525T
23 Gauge

Curved (R 12mm)



RD-1526T
20 Gauge

RD-1527T
23 Gauge

Straight Blunt Tips



RD-1528T
20 Gauges

RD-1529T
23 Gauge

Straight Pointed Tips



RD-1530T
20 Gauges

RD-1531T
23 Gauge

Vertical 40°



RD-1532T
20 Gauge

RD-1533T
23 Gauge

Vertical 80°



RD-1534T
20 Gauges

RD-1535T
23 Gauge

Vertical, Lower Blade with Bead Tip



RD-1536T
20 Gauge

RD-1537T
23 Gauge

Alio MICS Scissors

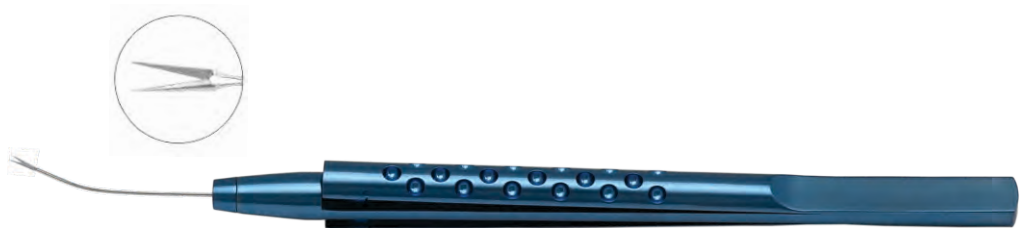

RD-1538T

23 Gauge, Curved Shaft Length 28mm
with Horizontal Micro Blades, Tips Length 2.7mm

Dalk Air Cannula



RD-1560
27 Gauge, Flattened

Rycroft Air Injection Cannula

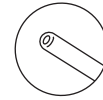

RD-1561
30 Gauge, Angle to Tip: 5mm

RD-1562
27 Gauge, Angle to Tip: 5mm

Langs Lacrimal Cannula



RD-1563
Curved, Long

Langs Lacrimal Cannula



RD-1564
Curved, Short

Harrison Butler Lacrimal Cannula



RD-1565

Binkhorst Irrigation Cannula

Smooth Blunt Tips
22 Gauge



RD-1566
Straight

RD-1567
Left

RD-1568
Right

■ Stainless Steel ■ Titanium

McIntyre Anterior Chamber Cannula

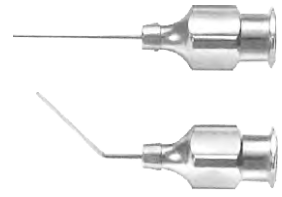
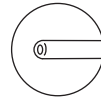

RD-1569
25 Gauge, Angled

RD-1570
23 Gauge, Straight

RD-1571
23 Gauge, Angled

RD-1572
26 Gauge, Straight

RD-1573
26 Gauge, Angled

RD-1574
30 Gauge, Straight

RD-1575
30 Gauge, Angled

Bishop-Harmon Irrigation Cannula

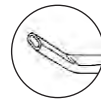

RD-1576 (44373-00)
Angle to Tips: 7mm, 19 Gauge

Simcoe Irrigation-Aspirating Cannula

for 12 O'Clock Aspiration, 23 Gauge
0.3mm Aspirating Side Port
with Silicone Tubing and Adapter

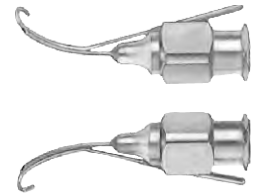

RD-1577
Right

RD-1578
Left

Jensen Posterior Capsule Polisher



RD-1579 (44340-00)
Sand Blasted Tip, 23 Gauge

RD-1580 (44350-00)
Sand Blasted Tip, 25 Gauge

Capsule Polishing Curette

Semi-Sharp Edges for Anterior and Posterior
Capsule Polishing Irrigation into Ring



RD-1581
25 Gauge

Gills Aspirating Cannula

Smooth blunt tips,
25 Gauge, Angled

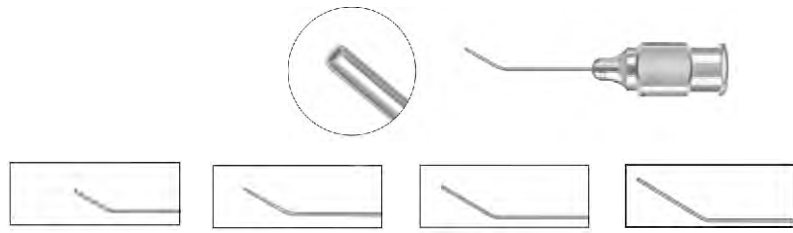

RD-1582
5mm Tip

RD-1583
7mm Tip

RD-1584
8mm Tip

RD-1585
10mm Tip

Simcoe Cortex Extractor

0.3mm Port Size, for Side Port
Cortex Removal



RD-1586
13mm, 23 Gauge

RD-1587
21mm, 23 Gauge

Knolle-Pearce Irrigating Vectis

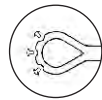

RD-1588
23 Gauge

Anis Irrigating Vectis



RD-1589
23 Gauge

Irrigating-Aspirating Cannula

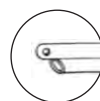
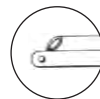

RD-1590 (44390-00)
Simcoe

RD-1591
Reverse Simcoe

CANNULAS

De La O Aspirating Cannula



RD-1592
0.3mm side port, Angled at 12mm, 25 Gauge

Morrison Aspirating Cannula



RD-1593
Smooth blunt tip, Angled at 7mm, 23 Gauge

Anis Cortex Aspirating Cannula



RD-1594
0.4mm side port, 23 Gauge, Straight

RD-1595
0.4mm side port, 23 Gauge, Angled

Wilbrandt-Binkhorst Cannula



RD-1596
Smooth blunt tip,
23 Gauge, Straight

RD-1597
Smooth blunt tip,
23 Gauge, Angled left

RD-1598
Smooth blunt tip,
23 Gauge, Angled right

McIntyre-Binkhorst Cannula



RD-1599
Smooth blunt tip,
26 Gauge, Straight

RD-1600
Smooth blunt tip,
26 Gauge, Angled left

RD-1601
Smooth blunt tip,
26 Gauge, Angled right

Bishop-Harmon Anterior Chamber Irrigator



Includes 19 gauge angled cannula, adapter
and blue silicon bulb

RD-1602 (44370-00)
Complete

RD-1603 (44371-00)
Silicon bulb

RD-1604 (44372-00)
Adapter

RD-1605 (44373-00)
19 gauge cannula

RD-1606 (44374-00)
21 gauge cannula

Nucleus Hydrodissection Cannula

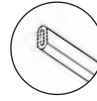

RD-1607
27 Gauge, Flat Angled Tip 8mm

RD-1608
25 Gauge, Flat Angled Tip 8mm

Kellan Hydrodissection Cannula



RD-1609
25 Gauge, Curved, Vertical Flattened Tip

Kellan Hydrodissection Cannula



RD-1610
25 Gauge, Curved Bevel Tip

LASIK Double Arm Cannula



RD-1611
25 Gauge, 8 Ports

RD-1612
Curved, 25 Gauge, 8 Ports

Guell LASIK Irrigation Cannula



RD-1613
25 Gauge, 7 Ports

Buratto LASIK Irrigation Cannula



RD-1614
25 Gauge, 3 Ports

Feaster Hydrodissection Cannula



RD-1615
25 Gauge, Wedge Shaped Tip

Chang Hydrodissection Cannula

27 Gauge, Flat 90° Angled Flat



RD-1616
Standard Tip

RD-1617
Long Tip

Simcoe Irrigating Lens Nucleus Loop

25 Gauge, Finely Serrated,
Strong Curve

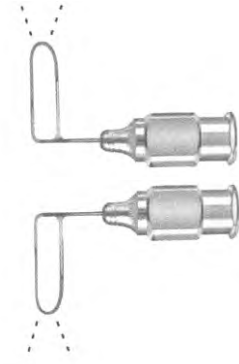

RD-1618
Right

RD-1619
Left

McIntyre Lacrimal Cannula

23 Gauge, Dual 0.3mm Side Port



RD-1620 (44310-00)
Straight

RD-1621 (44311-00)
Curved

Lacrimal Cannula

23 Gauge, Malleable Tip

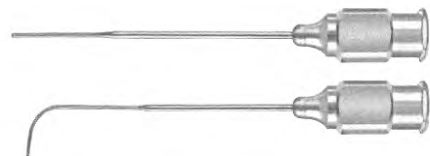

RD-1622 (44300-00)
Straight

RD-1623 (44301-00)
Curved

■ Stainless Steel ■ Titanium

Heslin Infusion Cannula



RD-1624
25 Gauge

RD-1625
23 Gauge

Infusion Cannula



RD-1626
22 Gauge, Self Retaining Tip

Brierley Chamber Maintainer

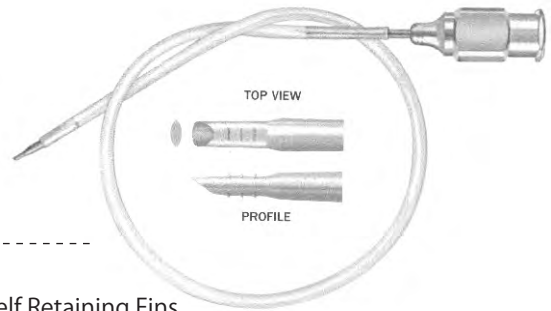

RD-1627
20 Gauge, Tapered Oval Tip with Self Retaining Fins

Lewicky Chamber Maintainer



RD-1628
20 Gauge, Threaded Tip

Dahan-Blumenthal Anterior Chamber Maintainer

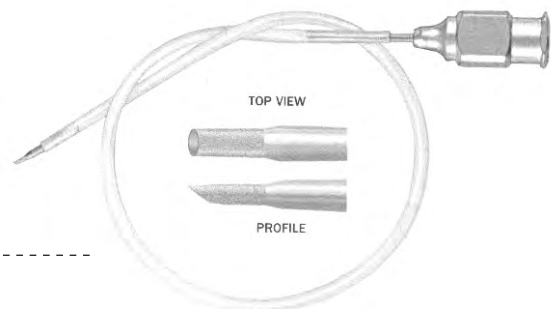

RD-1629
20 Gauge, Tapered Oval Tip

■ Stainless Steel ■ Titanium

Buratto Bi-Manual Irrigation Handpiece

Open End



RD-1641T
21 Gauge, Straight

RD-1642T
23 Gauge, Curved

Buratto Bi-Manual Irrigation Handpiece

Dual Port



RD-1643T
21 Gauge, Straight
Port Size 0.5mm

RD-1644T
21 Gauge, Curved
Port Size 0.5mm

RD-1645T
23 Gauge, Straight
Port Size 0.4mm

RD-1646T
23 Gauge, Curved
Port Size 0.4mm

Buratto Bi-Manual irrigating Handpiece



RD-1647T
21 Gauge, Curved
Port Size 0.4mm

RD-1648T
23 Gauge, Curved
Port Size 0.3mm

Buratto Bi-Manual Aspiration Handpiece



RD-1649T
21 Gauge, Curved
Port Size 0.4mm

RD-1650T
23 Gauge, Curved
Port Size 0.3mm

Buratto Bi-Manual Aspiration Handpiece



RD-1651T
21 Gauge, Port Size 0.35mm
Curved with Capsule Polisher

Gills-Colibri Forceps



RD-1661, **RD-1661T**
Very Fine Pointed Tips

Colibri Forceps

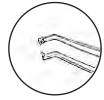

RD-1662, **RD-1662T** (43885-07)
Very Delicate, 1x2 Teeth, 0.12mm

Harms-Colibri Forceps

With Tying Platform



RD-1663, **RD-1663T**
Very Delicate, 1x2 Teeth, 0.12mm

Pierse-Colibri Corneal Forceps

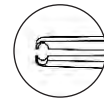

RD-1664, **RD-1664T**
Very Delicate

Castroviejo-Colibri Forceps

Very Delicate, 1x2 Teeth, 0.12mm



RD-1665, **RD-1665T**
Without Tying Platform

RD-1666, **RD-1666T**
With Tying Platform

Polack Double Corneal Suturing Forceps



RD-1667, **RD-1667T**
1x2 Teeth, 0.1mm, Very Delicate

Bonn Forceps

With Tying Platform

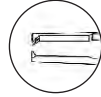

RD-1668, **RD-1668T**
Short Handle, 1x2 Teeth, 0.12mm

RD-1669, **RD-1669T**
Long Handle, 1x2 Teeth, 0.12mm

McPherson Corneal Forceps

With Tying Platform



RD-1670, **RD-1670T**
Straight, 1x2 Teeth, 0.4mm

RD-1671, **RD-1671T**
Angled, 1x2 Teeth, 0.4mm

Kelman-McPherson Forceps



RD-1672, **RD-1672T**
Angled, 1x2 Teeth, 0.3mm, 8mm Long Tying Platform

Hoffer-McPherson Forceps



RD-1673, **RD-1673T**
Angled, Very Delicate, 1x2 Teeth, 0.12mm, 11mm Long Tying Platform

Castroviejo Suturing Forceps

1x2 Teeth with Tying Platform



RD-1674, RD-1674T (44150-01B) 0.12mm	RD-1675, RD-1675T (44150-03B) 0.3mm	RD-1676, RD-1676T (44150-05B) 0.5mm	RD-1677, RD-1677T (44150-09 B) 0.9mm	RD-1678, RD-1678T (44150-15B) 1.5mm
---	--	--	---	--

Castroviejo Suturing Forceps

Angled, 1x2 Teeth, With Tying Platform

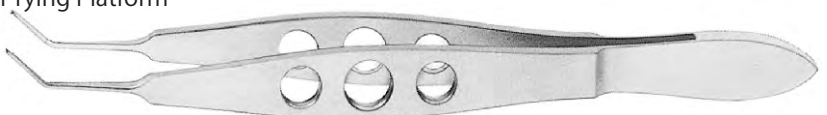

RD-1679, **RD-1679T**
0.3mm

RD-1680, **RD-1680T**
0.5mm

■ Stainless Steel ■ Titanium

Hoskin Corneal Forceps

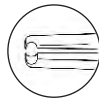

RD-1681, **RD-1681T**
Straight, Fine Grooved Tips

Hoskin Corneal Forceps

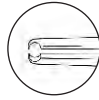

RD-1682, **RD-1682T**
Straight, Micro Grooved Tips

Hoskin Corneal Forceps

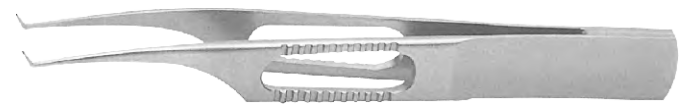
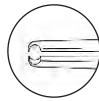

RD-1683, **RD-1683T**
Straight, Colibri Style, Micro Grooved Tips

McPherson Tying Forceps

5mm Long Smooth Tips
for 8-0 to 11-0 Sutures

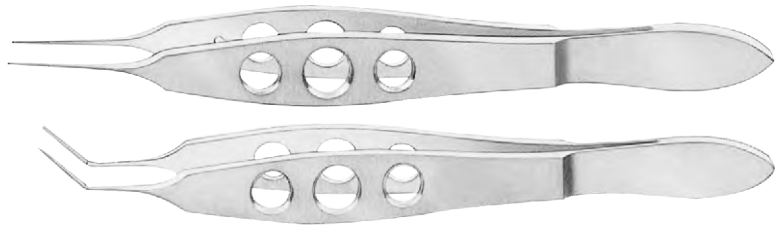

RD-1684, **RD-1684T**
Straight

RD-1685, **RD-1685T**
Angled

Kelman-McPherson Forceps



RD-1686, **RD-1686T**
Very Delicate, 7.5mm Long Smooth Tips

Bechert Forceps



RD-1687, **RD-1687T**
Angled, Very Delicate, 10mm Long Smooth Tips

Gaskin Fragment Forceps

11mm Long Smooth Tips
Very Delicate



RD-1688, RD-1688T
Angled

Tennant Tying Forceps

Extra Delicate, Smooth Tips
for 9-0 to 11-0 Sutures
6mm Long Platform

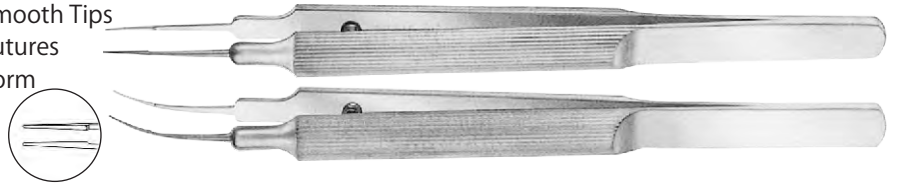

RD-1689, RD-1689T
Straight

RD-1690, RD-1690T
Curved

Harms Tying Forceps

for 7-0 to 9-0 Sutures
Smooth Tips

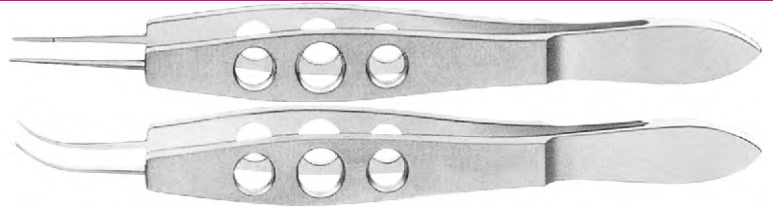

RD-1691, RD-1691T
Straight

RD-1692, RD-1692T
Curved

Jaffe Utility Forceps

for 7-0 to 9-0 Sutures



RD-1693, RD-1693T
Very delicate smooth jaws, Curved

Foreign Body Forceps



RD-1694, RD-1694T
Straight, Sharp Pointed Tips

Bonaccolto Utility & Splitter Forceps



RD-1695, RD-1695T
Straight, Very Delicate, Criss-Cross Serrated Tips

■ Stainless Steel ■ Titanium

Mendez Multi-Purpose LASIK Forceps



RD-1696, [RD-1696T](#)
Smooth Grasping Surfaces, Spatulated Jaws and Tips

Utrata Capsulorhexis Forceps



RD-1697, [RD-1697T](#)
Very Delicate, Short Handle, Triangular Grasping Tips

Masket Capsulorhexis Forceps



RD-1698, [RD-1698T](#)
Very Delicate, Short Handle, Triangular Grasping Tips

Kraff Capsule Tag Forceps



RD-1699, [RD-1699T](#)
11mm Long Shanks, 1.5mm Long Tips

Giannetti MICS Capsulorhexis Forceps

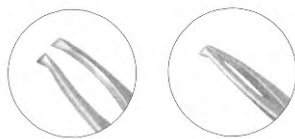

RD-1700, [RD-1700T](#)
Ultra Delicate Shanks Tips, Maximum Jaw Opening 2mm

■ Stainless Steel ■ Titanium

Utrata Capsularhexis Forceps



RD-1701T

Delicate Straight Shaft 11.5mm Long Shank
Round Handle 8mm Dia.

Utrata Capsularhexis Forceps

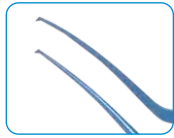

RD-1702T

Delicate Curved Shaft 11.5mm Long Shank
Round Handle 8mm Dia.

Utrata Capsularhexis Forceps

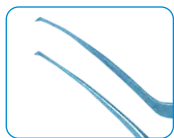

RD-1703T

Delicate Curved Shaft 10mm Long Shank
Round Handle 8mm Dia.

Utrata Capsularhexis Forceps



RD-1704

Extra Delicate Curved Shaft 11mm Long Shank
Round Handle 6mm Dia.

Dodick Nucleus Cracker



RD-1705, **RD-1705T**
Cross Action

Kraff Capsule Tag Forceps



RD-1706, **RD-1706T**
11mm Long Tips, 1.5mm Long Smooth Platform

Utrata Capsulorhexis Forceps



RD-1707, **RD-1707T**
Very Delicate Grasping Tips and Extremely Thin, 11mm Long Shanks

Utrata Capsulorhexis Forceps



RD-1708, **RD-1708T**
Round Handle, Very Delicate Grasping Tips and Extremely Thin 11mm Long Shanks

Masket Capsulorhexis Forceps



RD-1709, **RD-1709T**
Very Delicate Grasping Tips and Extremely Thin 11mm Long Shanks

Inamura Capsulorhexis Forceps

Incision Sealing Design



RD-1710, **RD-1710T**
Short for Corneal Incisions

RD-1711, **RD-1711T**
Long for Scleral Incisions

Micro Incision Capsulorhexis Forcep

Squeeze Handle



RD-1712T
23 Gauge, 15mm Shaft Length

RD-1713T
23 Gauge, 25mm Shaft Length

■ Stainless Steel ■ Titanium

Inamura Round Handle Capsularhexis Forceps for Scleral Tunnel Incision

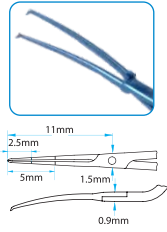

RD-1714T

Curved Shaft, Tip to Joint 11mm
45° Angled Tip, Cross Action 1.5mm Width at Box Joint

Inamura Round Handle Capsularhexis Forceps for Scleral Tunnel Incision

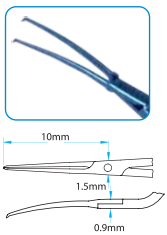

RD-1715T

Curved Shaft, Tip to Joint 10mm
45° Angled Tip, Cross Action 1.5mm Width at Box Joint

Inamura Capsularhexis Forceps

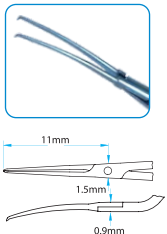

RD-1716T

Spring Action, 45° Angled Tip
Curved Shaft, Tip to Joint 11mm

Inamura Capsularhexis Forceps

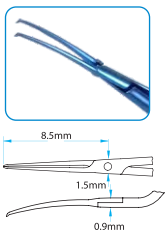

RD-1717T

Spring Action, 45° Angled Tip
Curved Shaft, Tip to Joint 8.5mm

Akahoshi Micro Prechopper Forceps



RD-1718T

Tips Height 1.3mm, Tips Open to 2.5mm
for Incision 1.7mm or more

Akahoshi Micro Prechopper Forceps



RD-1719T

Tips Height 1.5mm, Tips Open to 2.5mm
for Incision 1.7mm or more

Akahoshi Micro Prechopper Forceps



RD-1720T

Tips Height 1.6mm, Tips Open to 2.5mm
for Incision 1.7mm or more

Paddle Prechopper Forceps



RD-1721

Angled Shaft 45°, Tip to Angle Length 13.5mm
Tips Height 1.6mm, Tips Open to 2.5mm
for Incision 1.7mm or more

Fechtner Conjunctiva Forceps



RD-1722, [RD-1722T](#)
Very Delicate, Ring Shaped Tip with Tying Platform

Nugent Utility Forceps



RD-1723, [RD-1723T](#)
0.3mm Blunt Tips, Cross-action Mechanism

Stern- Conjunctiva Fixation Forceps



RD-1724, [RD-1724T](#)
1x2 Teeth 0.5mm with Lock

Moody Fixation Forceps

1x2 Teeth 0.5mm with Lock



RD-1725, [RD-1725T](#)
Left

RD-1726, [RD-1726T](#)
Right

Buratto LASIK Flap Forceps

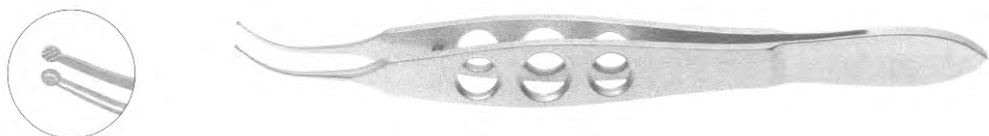

RD-1727, [RD-1727T](#)
Disc Shaped, Serrated Jaws

Vitreo-Retinal Forcep

Squeeze Handle



Straight Forceps
with 1 x 2 Teeth



RD-1728T
20 Gauge

RD-1729T
23 Gauge

Serrated Crocodile Forceps
2mm & 4mm Long Tips



RD-1730T
20 Gauge

RD-1731T
23 Gauge

Side Gripping Forceps
Smooth Round Jaws
2.4mm



RD-1732T
20 Gauge

RD-1733T
23 Gauge

Gripping Forceps,
2.5mm Smooth,
Straight



RD-1734T
20 Gauge

RD-1735T
23 Gauge

Membrane Peeler,
Smooth, 45°



RD-1736T
20 Gauge

RD-1737T
23 Gauge

Membrane Peeler,
Grooved, 45°



RD-1738T
20 Gauge

RD-1739T
23 Gauge

Straight and
End Gripping Jaws



RD-1740T
20 Gauge

RD-1741T
23 Gauge

Gripping Forceps,
2.0mm Smooth
Rounded Tips



RD-1742T
20 Gauge

RD-1743T
23 Gauge

ILM Forceps



RD-1744T
20 Gauge

RD-1745T
23 Gauge

Foreign Body Forceps,
Three Claws



RD-1746T
20 Gauge

RD-1747T
23 Gauge

Bishop-Harmon Tissue Forceps

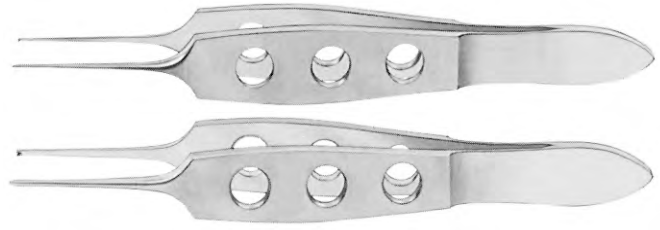

RD-1748, [RD-1748T](#) (43942-05)
Delicate, 1x2 Teeth, 0.5mm

RD-1749, [RD-1749T](#) (43942-08)
Standard, 1x2 Teeth, 0.8mm

Bishop-Harmon Dressing Forceps



RD-1750, [RD-1750T](#) (43940-08)
Serrated Tips, 0.5mm

RD-1751, [RD-1751T](#) (43940-05)
Serrated Fine, 0.5mm

Sauer Fixation Forceps



RD-1752, [RD-1752T](#)
1x2 Teeth

Manhattan Fixation Forceps

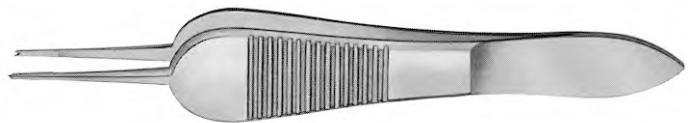

RD-1753, [RD-1753T](#)
1x2 Angled Teeth with Tying Platform

Graefe Dressing Forceps

Serrated, Delicate

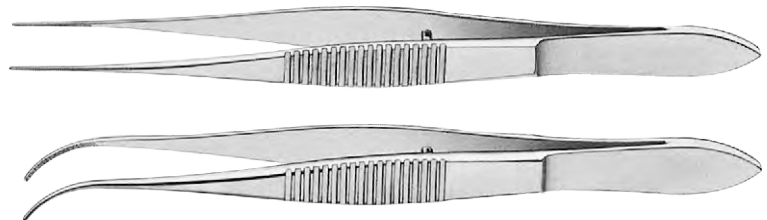

RD-1754 (43810-10)
Straight

RD-1755 (43811-10)
Curved

■ Stainless Steel ■ Titanium

Graefe Tissue Forceps

1x2 Teeth, Delicate

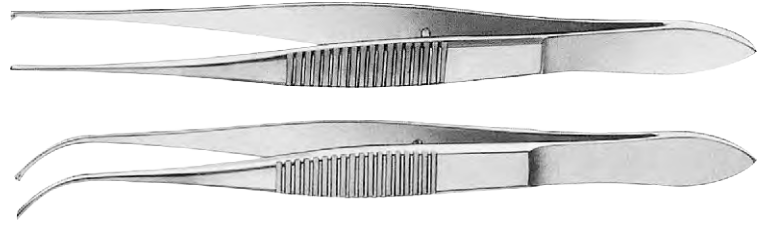

RD-1756 (43820-10)
Straight

RD-1757 (43821-10)
Curved

Elsching Scleral Forceps



RD-1758 (44046-11)
Delicate

Remky Superior Rectus Forceps



RD-1759

Graefe Fixation Forceps



RD-1760 (44050-11)
4.5mm Wide

FORCEPS

Nugent Utility Forceps



RD-1761
Smooth Jaws

RD-1762
Serrated Jaws

Bonaccolto Conjunctiva Forceps



RD-1763 (43916-10)
1.2mm wide, Serrated jaws

RD-1764 (43920-11)
1.7mm wide, Serrated jaws

Adson

125mm Long, Straight



1x2 teeth, delicate

RD-1765 (11176-12)
Dressing Forceps,
Serrated Jaws,
Delicate, 0.9mm

RD-1766 (11170-12)
Dressing Forceps,
Serrated Jaws,
Standard, 1.3mm

RD-1767 (11186-12)
Tissue Forceps,
1x2 Teeth,
Delicate, 0.9mm

RD-1768 (11180-12)
Tissue Forceps,
1x2 Teeth,
Standard, 1.3mm

Bayonet Dressing Forceps



3/4

RD-1769 (45206-14)
146mm Long, Serrated Jaws

Green Fixation Forceps



RD-1770 (44076-05)
5mm Wide, Multiple Teeth

RD-1771 (44076-10)
10mm Wide, Multiple Teeth

Barraquer Cilia Forceps



RD-1772
Lightly Angled, Smooth

Cilia Forceps



RD-1773
Slanted

Jewelers Forceps



RD-1774, RD-1774T (11401-01)
Standard, No. 1

Jewelers Forceps



RD-1775, RD-1775T (11403-04)
Delicate, Short, No. 3C

Jewelers Forceps



RD-1776, RD-1776T (11403-03)
Delicate, No. 3

FORCEPS

Jewelers Forceps



RD-1777, [RD-1777T](#) (11404-04)
Delicate, No. 4

Jewelers Forceps



RD-1778, [RD-1778T](#) (11405-05)
Extra Delicate, No. 5

Jewelers Forceps



RD-1779, [RD-1779T](#) (11411-11)
Extra Delicate, Angled, No. 5

Jewelers Forceps



RD-1780, [RD-1780T](#) (11407-07)
Curved, No. 7

Baby Jones Towel Clamp



RD-1781 (15103-07)
Cross-Action, 66mm

Backhaus Towel Clamp



RD-1782 (15111-09)
9cm

RD-1783 (15111-13)
13cm

Serrefine Small



RD-1784 (13102-04)
Straight, 4cm

RD-1785 (13103-04)
Curved, 4cm

Hartmann Mosquito Forceps

95mm



RD-1786 (13210-10)
Straight

RD-1787 (13211-10)
Curved

Halstead

125mm



RD-1788 (13220-12)
Straight

RD-1789 (13221-12)
Curved

Jameson Muscle Forceps

With Slide Lock
6 Teeth



RD-1790 (43909-10)
Right

RD-1791 (43907-10)
Left

Ptosis Lid Clamp



RD-1792
6-Pin, Concave

Berke Ptosis Forceps

With Slide Lock



RD-1793 (44015-20)
20mm Jaws

RD-1794 (44015-27)
27mm Jaws

Lambert Chalazion Forceps



RD-1795 (44246-09)
Round, 8mm Dia.

Hunt Chalazion Forceps

Delicate 95mm



RD-1796
Round, 12mm Dia.

Desmarres Chalazion Forceps

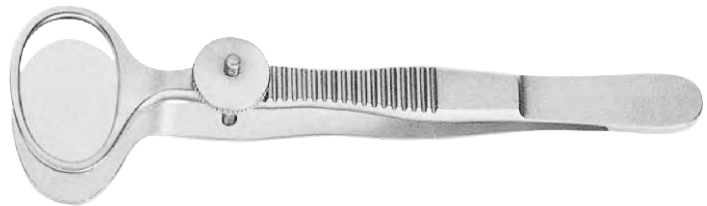

RD-1797 (44254-09)
Small, 20mm

RD-1798 (44256-09)
Medium, 24mm

RD-1799 (44258-09)
Large, 32mm

Snellen Entropion Forceps

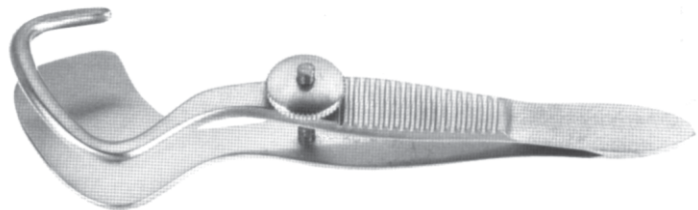

RD-1800 (44267-10)
Right

RD-1801 (44265-10)
Left

Watzke Sleeve Spreading Forceps



RD-1802
Serrated 10mm tips, Angled 30°

Lens Holding Forceps

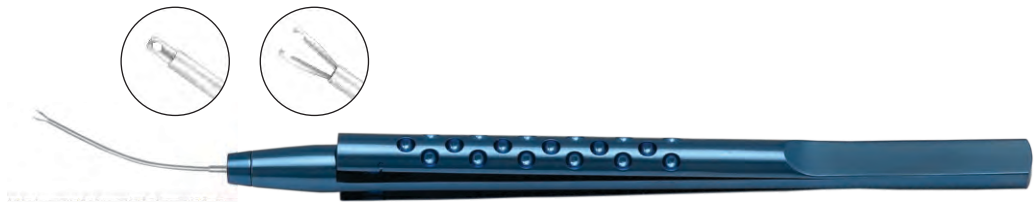

RD-1803T

23 Gauge, Delicate End, 90° Jaws, Squeeze Handle Mechanism

ICL Lens Cartridge Loading Forceps



RD-1804T

20 Gauge, Straight

Micro Lens Cutter

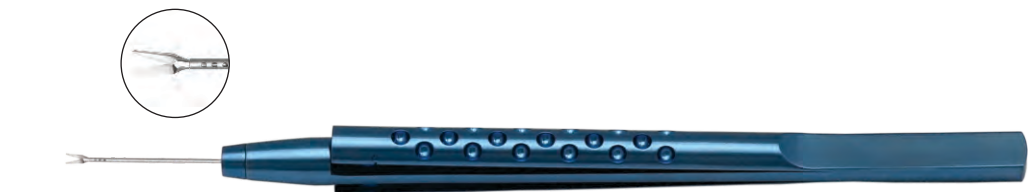

RD-1805T

For cutting soft acrylic and silicone IOLs
4mm long Stainless steel notched blades.

Lens Cutting & Holding Forceps



RD-1806T

To cut and remove all types of foldable intraocular Lens
Flat Titanium Handle Double Action, Stainless Steel Tips

Lens Cutting Forceps

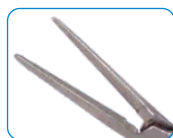

RD-1807T

Blade Length 7.7mm
Flat Titanium Double Action, Stainless Steel Tips

Livernois Pick-up & Holding Forceps

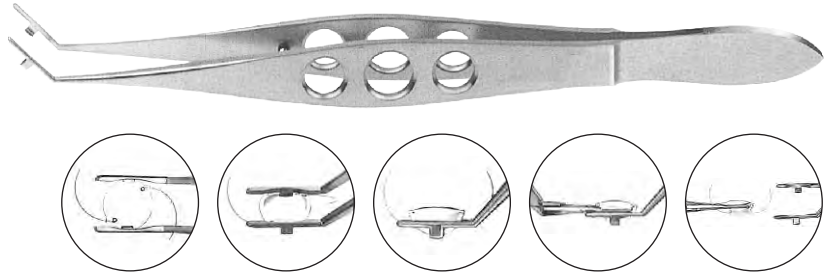

RD-1808, **RD-1808T**
for Soft IOL in One Motion

Livernois Pick-up & Holding Forceps

IOL Holding Forceps
Highly Polished Conical Jaws



RD-1809, **RD-1809T**
Straight

RD-1810, **RD-1810T**
Angled

Faulkner Lens Holding Forceps



RD-1811, **RD-1811T**
Smooth jaws, Rounded

Kelman-McPherson Lens Holding Forceps

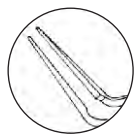

RD-1812, **RD-1812T**
Cross-Action

Ernest-McDonald IOL Inserting Forceps



RD-1813, **RD-1813T**
5mm Jaws, Cross-Action

RD-1814, **RD-1814T**
6mm Jaws, Cross-Action

Spaleck Soft IOL Inserting Forceps

For Foldable Acrylic and Thin Silicone Lenses

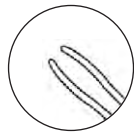

RD-1815, **RD-1815T**
Extra Delicate

Bipolar Forceps Jewelers Type



RD-1816
Pointed tips, Straight

Bipolar Forceps McPherson Type



RD-1817
Blunt tips, Angled

Bipolar Coaptation Forceps



RD-1818
Pointed Tips

Bipolar Cord

Please refer to our Laparoscopy catalogue for more information!

Sinsky Lens Holding Forceps



RD-1820, [RD-1820T](#)
Delicate T-Shaped

Jaffe-Blaydes Lens Holding Forceps



RD-1821, [RD-1821T](#)
Very Delicate, Angled 30°, Narrow Smooth Jaws

Clayman Lens Holding Forceps



RD-1822, [RD-1822T](#)
Delicate Angled Jaws

Kratz Lens Holding Forceps



RD-1823, [RD-1823T](#)
Very Delicate, Curved, Narrow Smooth Jaws

Shepard Lens Holding Forceps



RD-1824, [RD-1824T](#)
With Serrated Lower Jaw

Castroviejo Needleholder

Delicate Jaws, 140mm Long



RD-1831
Straight, with Lock

RD-1833
Curved, with Lock

RD-1832 (25678-14)
Straight, without Lock

RD-1834 (25679-14)
Curved, without Lock

Castroviejo Needleholder

Standard Jaws, 140mm Long



RD-1835 (25670-14)
Straight

RD-1836 (25671-14)
Curved

Silcocks Needleholder

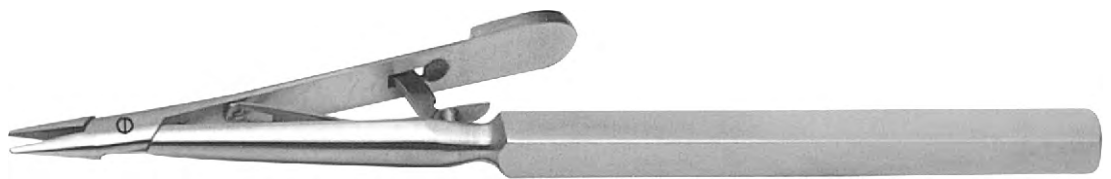

RD-1837 (25612-15)
145mm 5.75"

Kalt Needleholder



RD-1838 (25628-14)
Delicate smooth jaws, Straight with lock

Birks Needleholder



RD-1839, [RD-1839T](#)
Extra Delicate, Without Lock

Drews Needleholder

Extra Delicate Jaws



RD-1840, [RD-1840T](#)
Straight, With Lock

RD-1841, [RD-1841T](#)
Straight, Without Lock

RD-1842, [RD-1842T](#)
Curved, With Lock

RD-1843, [RD-1843T](#)
Curved, Without Lock

Barraquer Needleholder

Short Model, Very Delicate Jaws 10cm



RD-1844, [RD-1844T](#)
(25656-10)
Straight, With Lock

RD-1845, [RD-1845T](#)
(25650-10)
Straight, Without Lock

RD-1846, [RD-1846T](#)
(25657-10)
Curved, With Lock

RD-1847, [RD-1847T](#)
(25651-10)
Curved, Without Lock

Barraquer Needleholder

Very Delicate Curved Jaws 13cm

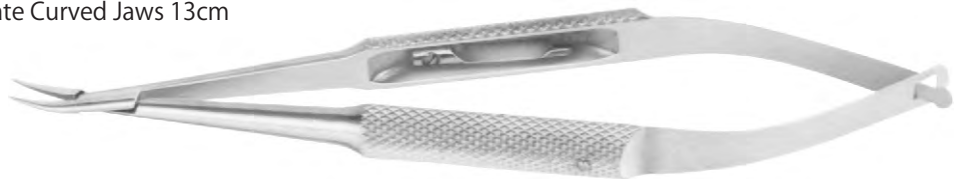

RD-1848, [RD-1848T](#)
With Lock

RD-1849, [RD-1849T](#)
Without Lock

Troutman Needleholder

Delicate, Strongly Curved Jaws

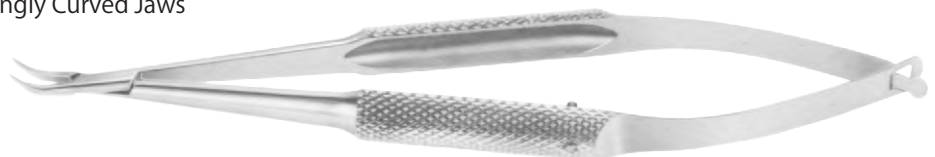

RD-1850, [RD-1850T](#)
With Lock

RD-1851, [RD-1851T](#)
Without Lock

McPherson Needleholder

Extra Delicate Jaws

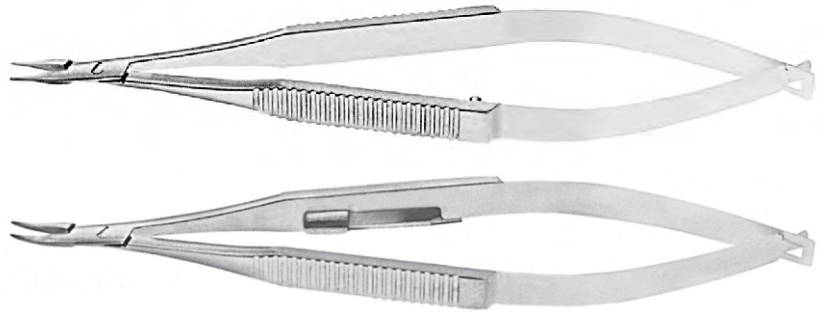

RD-1852, **RD-1852T**
Straight, With Lock

RD-1853, **RD-1853T**
Straight, Without Lock

RD-1854, **RD-1854T**
Curved, With Lock

RD-1855, **RD-1855T**
Curved, Without Lock

Extra Fine Needle Holder



RD-1856T
Straight, Length of Jaws 6mm
Flat Titanium Handle Double Action
Stainless Steel Tips

RD-1857T
Curved, Length of Jaws 6mm
Flat Titanium Handle Double Action
Stainless Steel Tips

Barraquer Needleholder

Standard Curved Jaws 13cm



RD-1858, **RD-1858T** (25731-13)
With Lock

RD-1859, **RD-1859T** (25661-13)
Without Lock

Anis Needleholder

Extra Delicate Jaws



RD-1860, **RD-1860T**
Straight, With Lock

RD-1861, **RD-1861T**
Straight, Without Lock

RD-1862, **RD-1862T**
Curved, With Lock

RD-1863, **RD-1863T**
Curved, Without Lock

■ Stainless Steel ■ Titanium

Corneal Trephine Blades & Handles



RD-1896
Universal Trephine Handle

RD-1881 6.0mm	RD-1882 6.5mm	RD-1883 6.75mm	RD-1884 7.0mm	RD-1885 7.25mm
RD-1886 7.5mm	RD-1887 7.75mm	RD-1888 8.0mm	RD-1889 8.25mm	RD-1890 8.5mm
RD-1891 8.75mm	RD-1892 9.0mm	RD-1893 9.5mm	RD-1894 14.0mm	RD-1895 16.0mm

Schiotz Tonometer

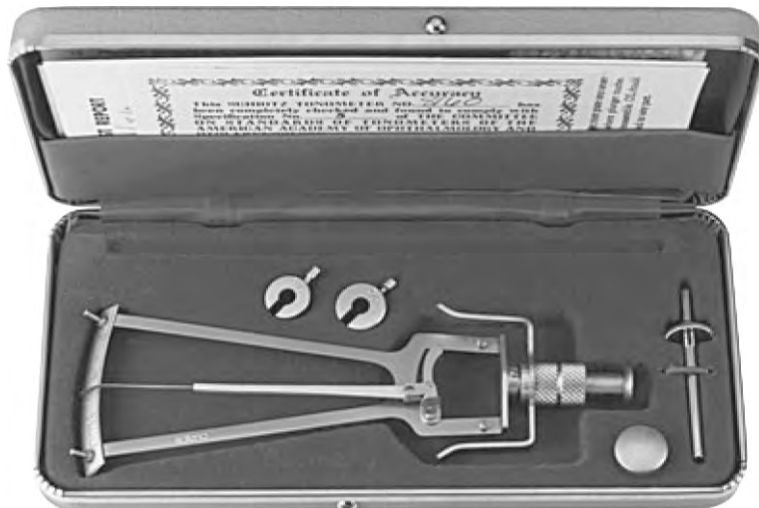

RD-1900 (44406-00)
autoclavable,
inclined scale

STERILIZING TRAYS

Sterilizing Tray

With Silicon Mat
(25cm x 15cm x 1.9cm)

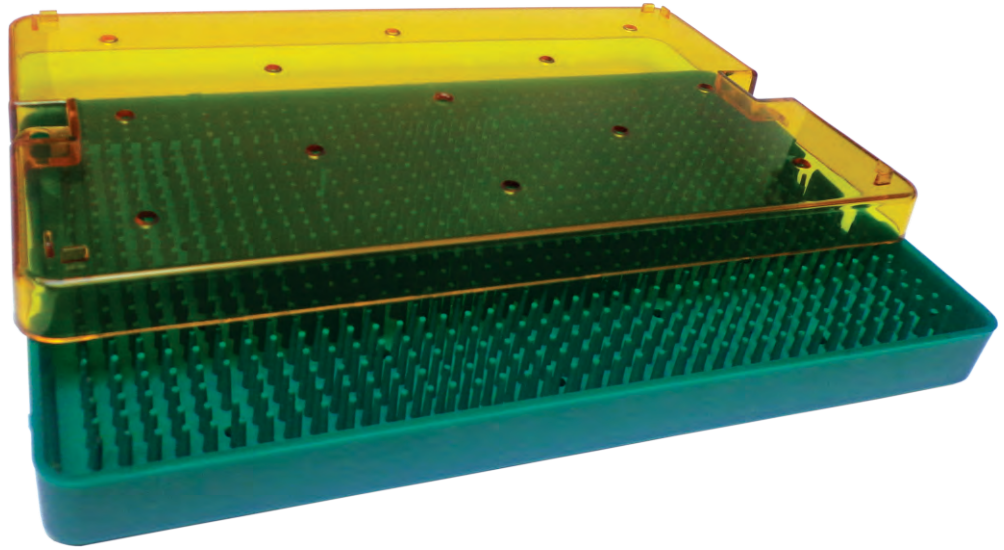

RD-1901

Autoclaving, Steam & Ethylene Oxide Sterilizing
Silicone Mat, Protection for Instruments
Sterilization and Storage

Sterilizing Tray

With Two Silicon Inserts
(17cm x 6.5cm x 2cm)

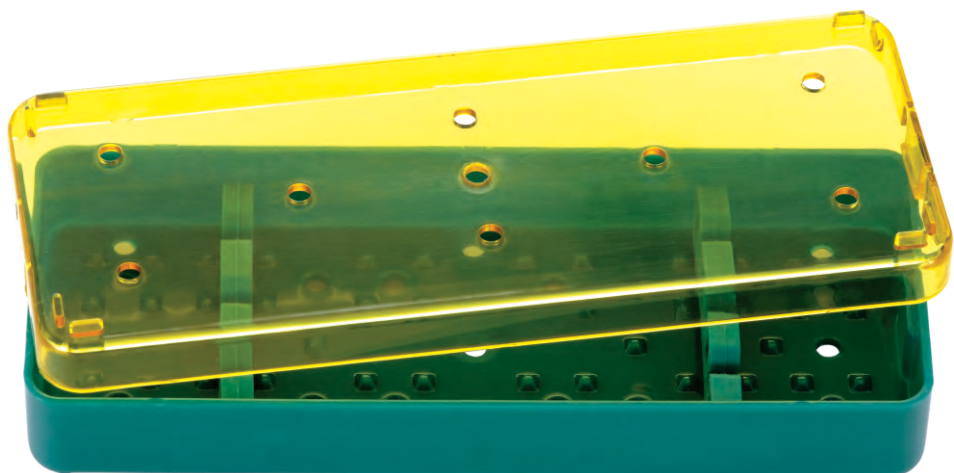

RD-1902

Autoclaving, Steam & Ethylene Oxide Sterilizing
Pyramid Design Base for Better Steam Penetration
Sterilization and Storage

CATARACT SET

Extra Capsular Cataract Extraction Set / 331

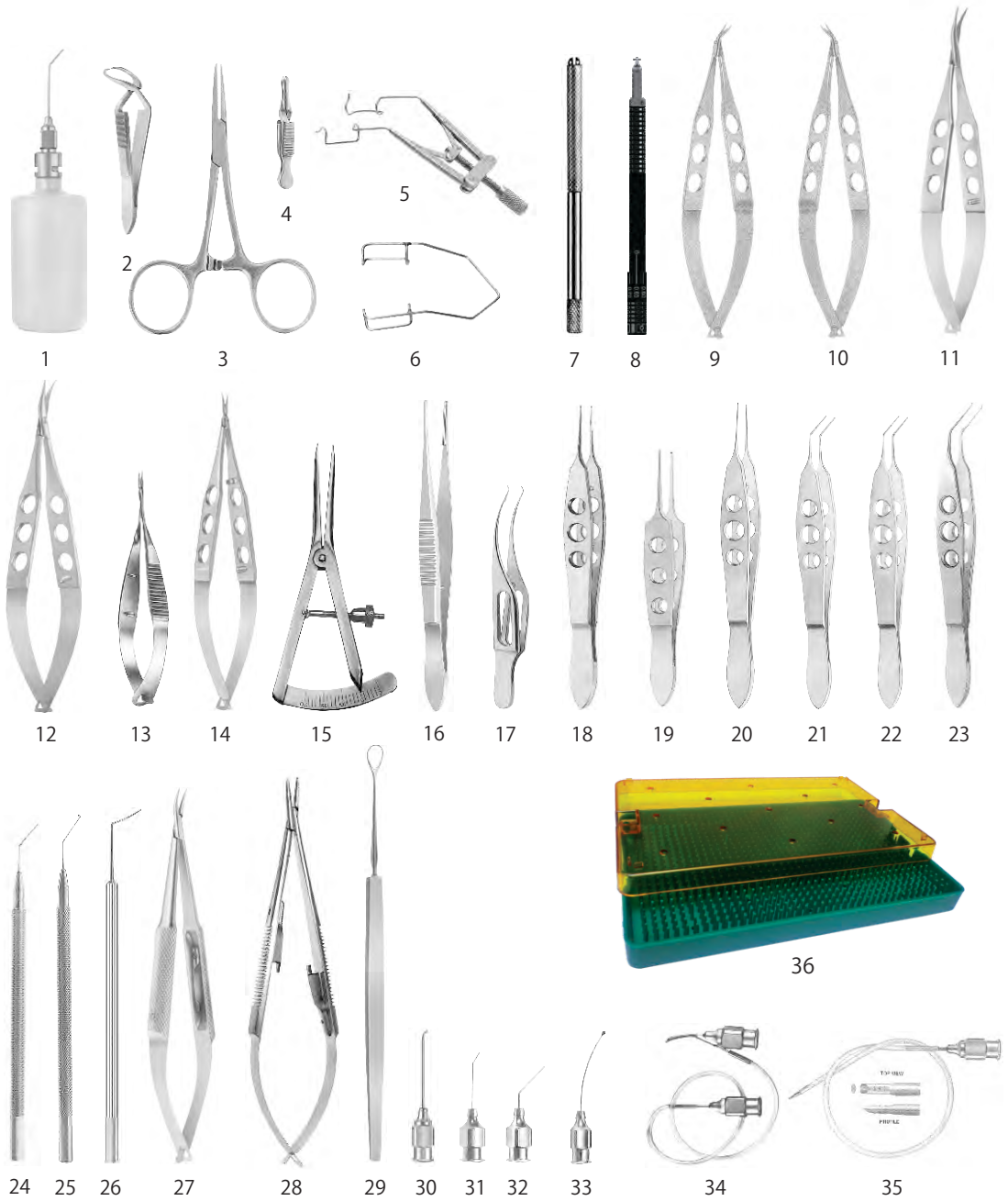

RD-1911

1. **RD-1602** Bishop-Harmon Anterior Chamber Irrigator Complete
2. **RD-1781** Baby Jones Towel Clamp Cross-Action, 66mm
3. **RD-1786** Hartmann Mosquito Forceps Straight
4. **RD-1784** Serrefine Small Straight 4cm
5. **RD-1013** Lieberman Style Wire Speculum 15mm, K-wire, Standard
6. **RD-1002** Barraquer Heavy Wire Speculum 14mm
7. **RD-1166** Scalpel Handles 10cm
8. **RD-1424T** Step Diamond Knife Tri-facet
9. **RD-1502** Castroviejo Corneoscleral Scissors Small blades, Right
10. **RD-1503** Castroviejo Corneoscleral Scissors Small blades, Left
11. **RD-1489** Westcott Tenotomy Scissors Blunt tips, Medium blades, Curved
12. **RD-1488** Jaffe Stitch Scissors, pointed tips, Medium blades, Curved
13. **RD-1511** Vannas Capsulotomy Scissors Curved, Blade Length: 7mm
14. **RD-1520** Capsulotomy Scissors Stern-Gills, Angled forward, 10mm
15. **RD-1097** Castroviejo Caliper Straight, 20mm Spread
16. **RD-1763** Bonacollo Conjunctiva Forceps 1.2mm wide, Serrated Jaws
17. **RD-1663** Harms-Colibri Forceps Very Delicate, 1x2 Teeth, 0.12mm
18. **RD-1668** Bonn Forceps Short Handle, 1x2 Teeth, 0.12mm
19. **RD-1749** Bishop-Harmon Tissue Forceps Standard
20. **RD-1684** McPherson Tying Forceps 5mm Long Smooth Tips Straight
21. **RD-1685** McPherson Tying Forceps 5mm Long Smooth Tips Angled
22. **RD-1686** Kelman-McPherson Forceps, Delicate, 7.5mm Long Smooth Tips
23. **RD-1707** Utrata Capsulorhexis Forceps Very Delicate Grasping Tips
24. **RD-1284** Sinsky II IOL Manipulating Hook Angled, 0.2mm, Blunt Tip
25. **RD-1290** Kuglen Iris Hook & Lens Manipulator Angled, Push-Pull Model
26. **RD-1226** Barraquer Iris Spatula Tip Width 0.50mm Round, Smooth
27. **RD-1849** Barraquer Needle Holder without Lock 13cm
28. **RD-1835** Castroviejo Needle Holder Straight
29. **RD-1244** Lewis & SNELLEN Lens Loop Large
30. **RD-1595** Anis Cortex Aspirating Cannula 0.4mm side port, 23 Gauge, Angled
31. **RD-1562** Rycroft Air Injection Cannula 27 Gauge, Angle to Tip: 5mm
32. **RD-1573** McIntyre Anterior Chamber Cannula 26 Gauge, Angled
33. **RD-1579** Jensen Posterior Capsule Polisher Sand Blasted Tip, 23 Gauge
34. **RD-1590** Irrigating-Aspirating Cannula Simcoe
35. **RD-1627** Brierley Chamber Maintainer 20 Gauge, Tapered Oval Tip
36. **RD-1901** Sterilizing Tray with Silicon Mat

CATARACT SET

Extra Capsular Cataract Extraction using Phacoemulsification Set / 332



RD-1912

1. **RD-1602** Bishop-Harmon Anterior Chamber Irrigator Complete
2. **RD-1013** Lieberman Style Wire Speculum 15mm, K-wire, Standard
3. **RD-1007** Wire Speculum Temporal Spring toward Nasal Side
4. **RD-1411T** Diamond Knives Tri-facet FH-MDS 5, 1x1, 0x0, 20mm / 45° / 30°
5. **RD-1415T** Diamond Knives Clear Cornea 90° FH-CC 6, 0x3,0x0,20mm /90° abg
6. **RD-1166** Scalpel Handles 10cm
7. **RD-1786** Hartmann Mosquito Forceps Straight
8. **RD-1781** Baby Jones Towel Clamp Cross-Action, 66mm
9. **RD-1349** Rosen Phaco Splitter Wedge Shaped
10. **RD-1290** Kuglen Iris Hook & Lens Manipulator Angled, Push-Pull Model
11. **RD-1297** Bechert Nucleus Rotator Angled 9mm, Blunt tip
12. **RD-1300** Lester IOL Manipulator 0.25mm dia. tip, Angled
13. **RD-1489** Westcott Tenotomy Scissors Blunt tips, Medium blades, Curved
14. **RD-1097** Castroviejo Caliper Straight, 20mm Spread
15. **RD-1520** Capsulotomy Scissors Stern-Gills, Angled forward, 10mm
16. **RD-1662** Colibri Forceps Very Delicate, 1x2 Teeth, 0.12mm
17. **RD-1674** Castroviejo Suturing Forceps 0.12mm
18. **RD-1722** Fechtner Conjunctiva Forceps Ring Shaped Tip
19. **RD-1689** Tennant Tying Forceps Extra Delicate, Smooth Tips Straight
20. **RD-1690** Tennant Tying Forceps Extra Delicate, Smooth Tips Curved
21. **RD-1707** Utrata Capsulorhexis Forceps Very Delicate Grasping Tips
22. **RD-1686** Kelman-McPherson Forceps, Delicate, 7.5mm Long Smooth Tips
23. **RD-1813** Ernest-McDonald IOL Inserting Forceps 5mm Jaws, Cross-Action
24. **RD-1808** Livernois Pick-up & Holding Forceps for Soft IOL in One Motion
25. **RD-1848** Barraquer Needle Holder with Lock 13cm
26. **RD-1705** Dodick Nucleus Cracker Cross Action
27. **RD-1590** Irrigating-Aspirating Cannula Simcoe
28. **RD-1568** Binkhorst Irrigation Cannula 22 Gauge Right
29. **RD-1567** Binkhorst Irrigation Cannula 22 Gauge Left
30. **RD-1608** Nucleus Hydrodissection Cannula 25 Gauge, Flat Angled Tip 8mm
31. **RD-1562** Rycroft Air Injection Cannula 27 Gauge, Angle to Tip: 5mm
32. **RD-1579** Jensen Posterior Capsule Polisher Sand Blasted Tip, 23 Gauge
33. **RD-1433** Fine-Thornton Swivel Fixation Ring 13mm Dia. Blunt Teeth
34. **RD-1817** Bipolar Forceps Jewelers Type Pointed tips, Straight
35. **RD-1819** Bipolar Cord Autoclave able
36. **RD-1511** Vannas Capsulotomy Scissors Curved, Blade Length: 7mm
37. **RD-1901** Sterilizing Tray with Silicon Mat



RD-1913

- | | |
|---|---|
| 1. RD-1019 Lieberman Style Wire Speculum 15mm, V-shaped | 11. RD-1707 Utrata Capsulorhexis Forceps Triangular Grasping Tips |
| 2. RD-1465 Maloney Intra-operative Keratometer Measurement of Astigmatism | 12. RD-1097 Castroviejo Caliper Straight, 20mm Spread |
| 3. RD-1705 Dodick Nucleus Cracker Cross Action | 13. RD-1489 Westcott Tenotomy Scissors Blunt tips, Medium blades, Curved |
| 4. RD-1284 Sinsky II IOL Manipulating Hook Angled , 0.2mm Dia. Blunt Tip | 14. RD-1488 Jaffe Stitch Scissors Very sharp pointed tips, Medium blades, Curved |
| 5. RD-1651T Buratto Bi-Manual Aspiration Hand piece 21 Gauge, Port Size 0.35mm | 15. RD-1609 Nucleus Hydrodissection Cannula 25 Gauge, Flat Angled Tip 8mm |
| 6. RD-1644T Buratto Bi-Manual Irrigation Hand piece 21 Gauge, Curved | 16. RD-1608 Nucleus Hydrodissection Cannula 25 Gauge, Flat Angled Tip 8mm |
| 7. RD-1415T Diamond Knives, Clear Cornea 90°, 2.8mm | 17. RD-1721 Paddle Prechopper Forceps, Angled |
| 8. RD-1411T Diamond Knives Tri-facet FH-MDS 5, 1x1, 0x0, 20mm / 45° / 30° | 18. RD-1718T Akahoshi Micro Prechopper Forceps Tips Height 1.3mm |
| 9. RD-1561 Rycroft Air Injection Cannula 30 Gauge, Angle to Tip: 5mm | 19. RD-1901 Sterilizing Tray with Silicon Mat |
| 10. RD-1290 Kuglen Iris Hook & Lens Manipulator Angled, Push-Pull Model | |

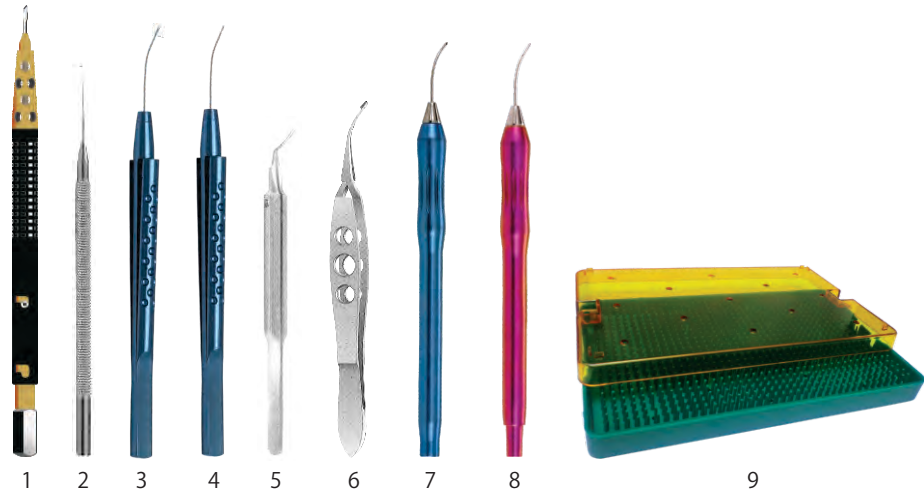

RD-1914

1. **RD-1416T** Diamond Knives Tapered Spear MICS FH-CC / 90° Angled
2. **RD-1299** Lester IOL Manipulator, Straight
3. **RD-1538T** Alio MICS Scissors 23 Gauge, Curved Shaft
4. **RD-1713T** Micro Incision Capsulorhexis Forceps, 23 Gauge
5. **RD-1700** Giannetti MICS Capsulorhexis Forceps Ultra Delicate Shanks Tips
6. **RD-1705** Dodick Nucleus Cracker Cross Action
7. **RD-1646T** Buratto Bi-Manual irrigating Hand piece 23 Gauge, Curved
8. **RD-1650T** Buratto Bi-Manual Aspiration Hand piece 23 Gauge, Curved
9. **RD-1901** Sterilizing Tray with Silicon Mat

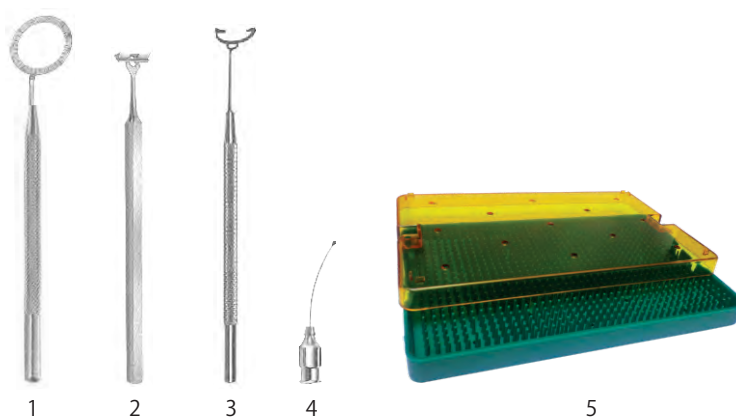

RD-1915

1. **RD-1438** Mendez Degree Gauge
2. **RD-1439** Bores Axis Marker
3. **RD-1446** Toric Marker Half-ring for mark of meridian 12 mm
4. **RD-1580** Jensen Posterior Capsule Polisher, 25 Gauge
5. **RD-1902** Sterilizing Tray with Two Silicon Inserts

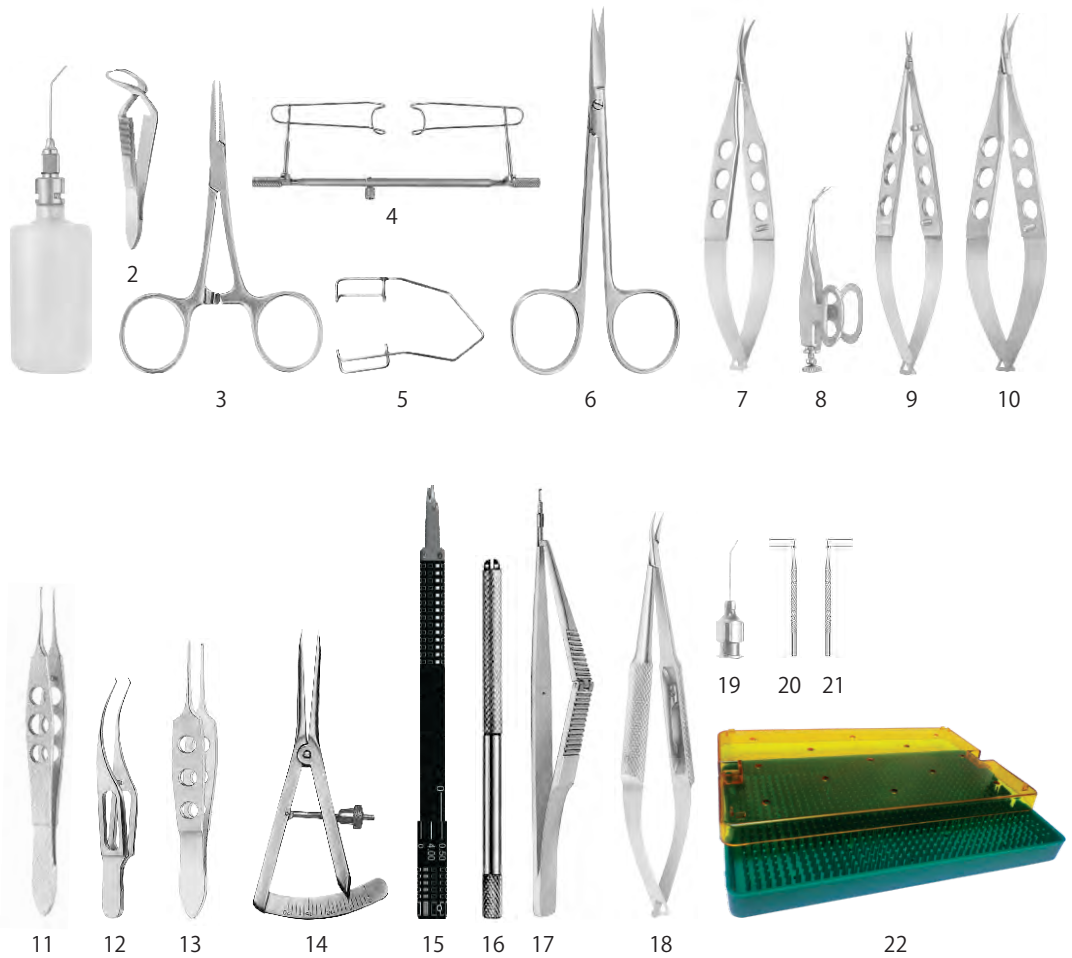

RD-1916

- | | |
|---|--|
| 1. RD-1602 Bishop-Harmon Anterior Chamber Irrigator | 12. RD-1662 Colibri Forceps, 1x2 Teeth, 0.12mm |
| 2. RD-1781 Baby Jones Towel Clamp | 13. RD-1749 Bishop-Harmon Tissue Forceps, Standard |
| 3. RD-1786 Hartmann Mosquito Forceps, Straight | 14. RD-1097 Castroviejo Caliper, Straight |
| 4. RD-1026 Schott Eye Speculum 16mm wire blades | 15. RD-1422T Diamond Knife with Glaucoma Surgery Step Knife |
| 5. RD-1002 Barraquer Heavy Wire Speculum | 16. RD-1166 Scalpel Handles, 10cm |
| 6. RD-1471 Eye Scissors Straight, Standard | 17. RD-1201 Kelly Punch |
| 7. RD-1489 Westcott Tenotomy Scissors Blunt tips, Curved | 18. RD-1849 Barraquer Needle Holder, Curved without Lock |
| 8. RD-1483 Barraquer Iris Scissors, Blunt tips | 19. RD-1562 Rycroft Air Injection Cannula, 27 Gauge |
| 9. RD-1516 Capsulotomy Scissors, Vannas Scissors, Curved | 20. RD-1135 Harms Trabeculotomy Probe with Suture Holes Left |
| 10. RD-1488 Jaffe Stitch Scissors, Curved | 21. RD-1136 Harms Trabeculotomy Probe with Suture Holes Right |
| 11. RD-1722 Fechtner Conjunctiva Forceps Ring Shaped Tip | 22. RD-1901 Sterilizing Tray with Silicon Mat |

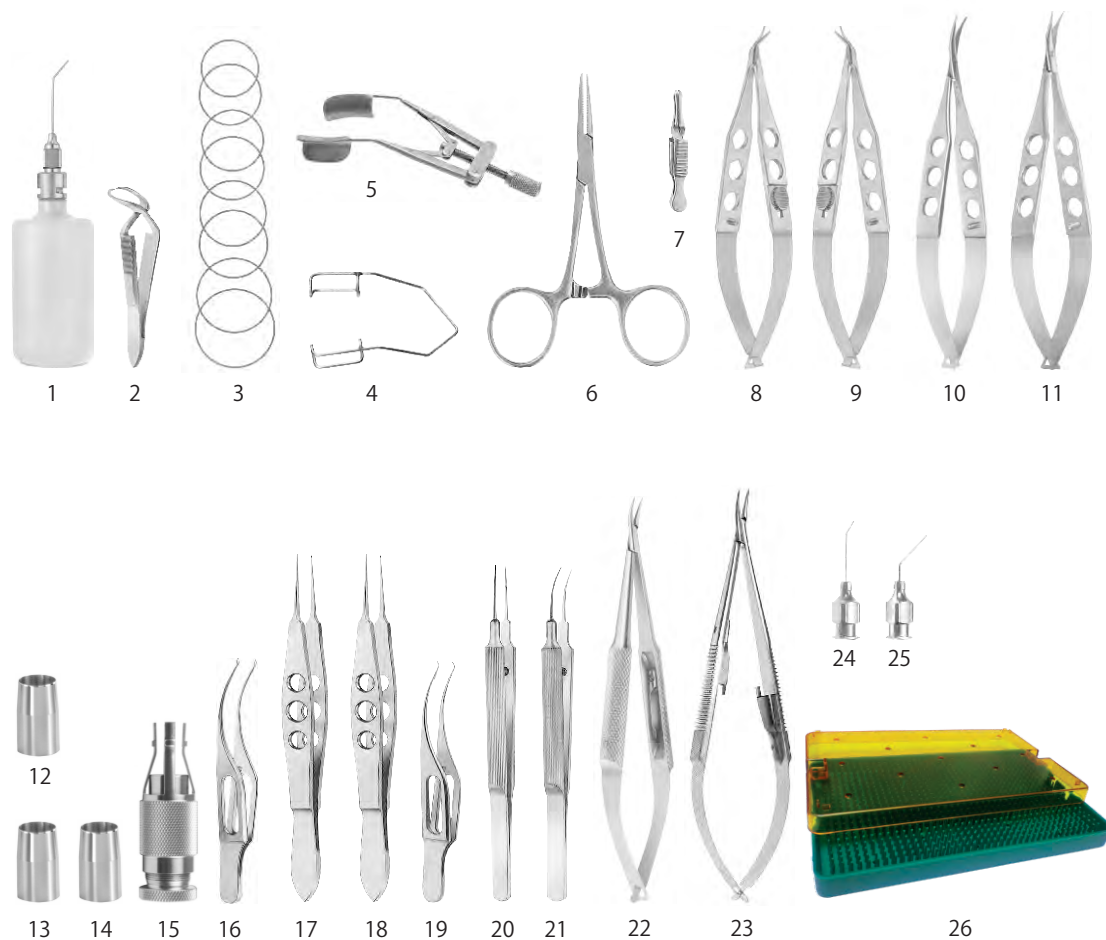

RD-1917

- | | |
|--|--|
| 1. RD-1602 Bishop-Harmon Anterior Chamber Irrigator | 14. RD-1890 Corneal Trephine Blades & Handles 8.5mm |
| 2. RD-1781 Baby Jones Towel Clamp | 15. RD-1896 Corneal Trephine Blades & Handles Universal Trephine Handle |
| 3. RD-1061 Flieringa Scleral Fixation Ring, Set of eight | 16. RD-1667 Polack Double Corneal Suturing Forceps |
| 4. RD-1002 Barraquer Heavy Wire Speculum | 17. RD-1674 Castroviejo Suturing Forceps, 0.12mm |
| 5. RD-1033 Lieberman Eye Speculum Solid Blades, Adjustable | 18. RD-1675 Castroviejo Suturing Forceps, 0.3mm |
| 6. RD-1786 Hartmann Mosquito Forceps, Straight | 19. RD-1663 Harms-Colibri Forceps |
| 7. RD-1784 Serrefine Small, Straight | 20. RD-1689 Tennant Tying Forceps, Straight |
| 8. RD-1498 Troutman-Castroviejo Scissors with stop, Small blades, Right | 21. RD-1690 Tennant Tying Forceps, Curved |
| 9. RD-1499 Troutman-Castroviejo Scissors with stop, Small blades, Left | 22. RD-1848 Barraquer Needle Holder with Lock |
| 10. RD-1489 Westcott Tenotomy Scissors, Blunt tips, Curved | 23. RD-1833 Castroviejo Needle Holder Curved, with Lock |
| 11. RD-1488 Jaffe Stitch Scissors, Curved | 24. RD-1561 Rycroft Air Injection Cannula, 30 Gauge |
| 12. RD-1886 Corneal Trephine Blades & Handles 7.5mm | 25. RD-1573 McIntyre Anterior Chamber Cannula, 26 Gauge |
| 13. RD-1888 Corneal Trephine Blades & Handles 8.0mm | 26. RD-1901 Sterilizing Tray with Silicon Mat |

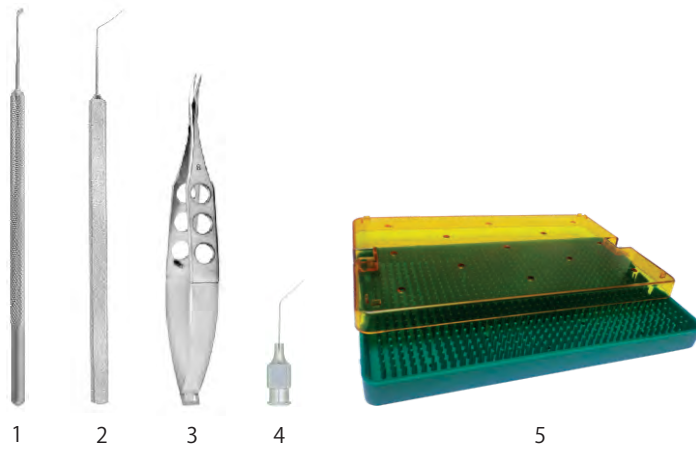

RD-1918

1. **RD-1191** DALK Lamellar Dissector Semi-sharp dissector
2. **RD-1392** DALK Corneal Dissector Triangular Shaft
3. **RD-1509** DALK Micro Scissors Left + Right Set
4. **RD-1560** DALK Air Injection Cannula
5. **RD-1901** Sterilizing Tray with Silicon Mat



RD-1919

1. **RD-1013** Lieberman Wire Speculum, K-wire
2. **RD-1405** Rowen Combination LASIK Spatula
3. **RD-1399** Hersh IntraLase Flap Spatula
4. **RD-1401** Fukasaku LASIK Spatula
5. **RD-1403** Katzen LASIK Flap "Unzipper"
6. **RD-1409** Thorlaxson Z-LASIK Flap Lifter
7. **RD-1435** Gimbel Stabilizing Ring
8. **RD-1727** Buratto LASIK Flap Forceps Disc Shaped, Serrated Jaws
9. **RD-1614** Buratto LASIK Irrigation Cannula 25 Gauge, 3 Ports
10. **RD-1039** Lieberman Aspirating Speculum 15mm
11. **RD-1901** Sterilizing Tray with Silicon Mat

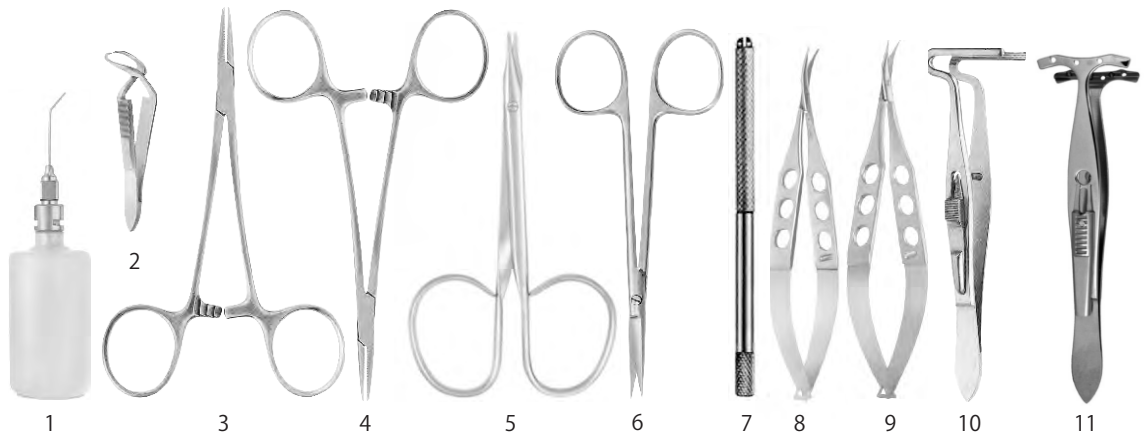

1 2 3 4 5 6 7 8 9 10 11

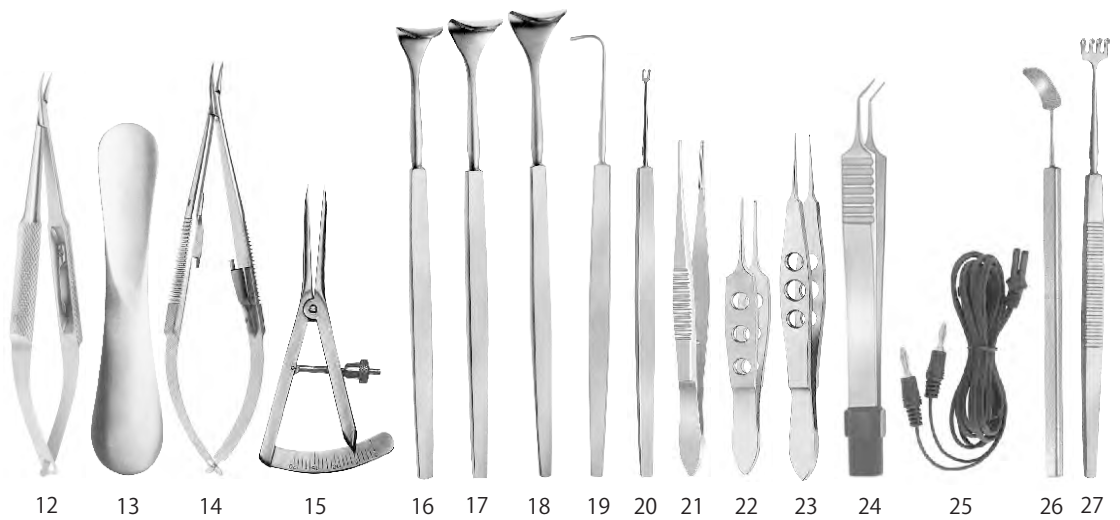

12 13 14 15 16 17 18 19 20 21 22 23 24 25 26 27

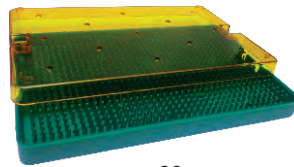

28

RD-1920

- | | |
|---|--|
| 1. RD-1602 Bishop-Harmon Anterior Chamber Irrigator | 15. RD-1097 Castroviejo Caliper, Straight |
| 2. RD-1781 Baby Jones Towel Clamp | 16. RD-1089 Desmarres Lid Retractor, Size-1 |
| 3. RD-1789 Halstead Mosquito Forceps, Curved | 17. RD-1090 Desmarres Lid Retractor, Size-2 |
| 4. RD-1788 Halstead Mosquito Forceps, Straight | 18. RD-1091 Desmarres Lid Retractor, Size-3 |
| 5. RD-1474 Stevens Scissors, Straight | 19. RD-1250 Graefe Muscle Hook, Size-2 |
| 6. RD-1471 Eye Scissors, Straight | 20. RD-1255 Fixation Hook Double, Sharp, Small |
| 7. RD-1166 Scalpel Handles, 10cm | 21. RD-1763 Bonaccolto Conjunctiva Forceps, Serrated Jaws |
| 8. RD-1489 Westcott Tenotomy Scissors, Curved | 22. RD-1749 Bishop-Harmon Tissue Forceps, Standard |
| 9. RD-1488 Jaffe Stitch Scissors, Curved | 23. RD-1675 Castroviejo Suturing Forceps, 0.3mm |
| 10. RD-1794 Berke Ptosis Forceps 27mm Jaws | 24. RD-1817 Bipolar Forceps Blunt tips, Angled |
| 11. RD-1792 Ptosis Lid Clamp 6 Pins | 25. RD-1819 Bipolar Cord Autoclaveable |
| 12. RD-1849 Barraquer Needle Holder without Lock | 26. RD-1096 Helveston Tissue Retractor, 11mm wide |
| 13. RD-1066 Jaeger Lid Plate | 27. RD-1087 Knapp Lacrimal Retractor, Sharp |
| 14. RD-1834 Castroviejo Needle Holder Curved, without Lock | 28. RD-1901 Sterilizing Tray with Silicon Mat |

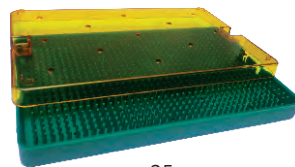
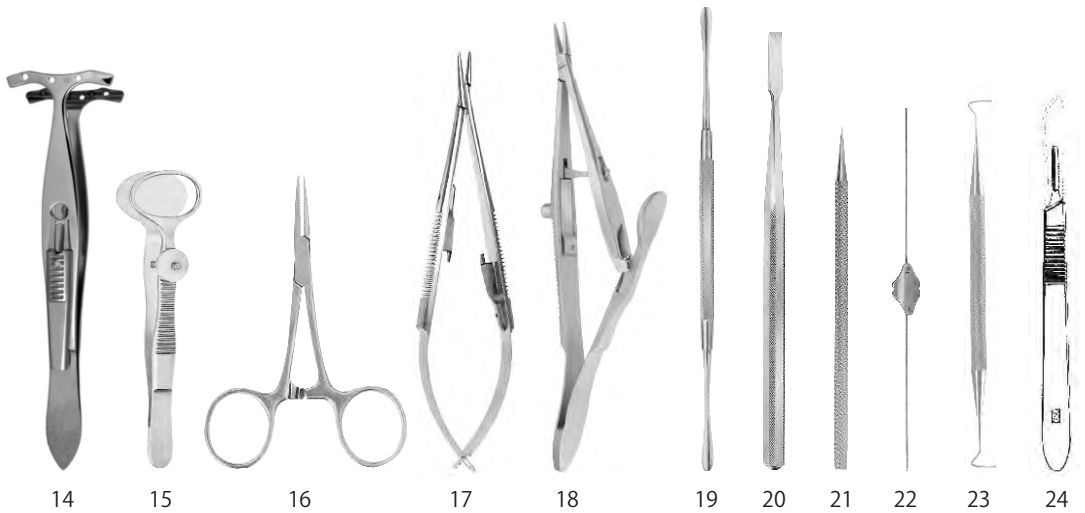

25

RD-1921

- | | |
|---|--|
| 1. RD-1032 Lancaster Eye Speculum 16mm | 14. RD-1792 Ptosis Lid Clamp, 6 Pins |
| 2. RD-1092 Schepens Orbital Retractor | 15. RD-1797 Desmarres Chalazion Forceps, Medium |
| 3. RD-1090 Desmarres Lid Retractor, Size-2 | 16. RD-1786 Hartmann Mosquito Forceps, Straight |
| 4. RD-1066 Jaeger Lid Plate | 17. RD-1835 Castroviejo Needle Holder, Straight |
| 5. RD-1101 Wright Fascia Needle | 18. RD-1838 Kalt Needle Holder Delicate, Straight with Lock |
| 6. RD-1086 Knapp Lacrimal Retractor 4-Prong, Blunt | 19. RD-1181 Freer Periosteal Elevator |
| 7. RD-1269 Meyerhoefer Chalazion Curette, Size-3 | 20. RD-1184 West Lacrimal Chisel, Straight |
| 8. RD-1273 Bunge Evisceration Spoon Large | 21. RD-1131 Wilder Lacrimal Dilator Size-2 |
| 9. RD-1256 Fixation Hook Double Sharp Large | 22. RD-1124 Bowman Malleable Lacrimal Probe Size 3 & 4 |
| 10. RD-1250 Graefe Muscle Hook, Size-2 | 23. RD-1134 Pigtail Probe with Suture Holes |
| 11. RD-1474 Stevens Scissor, Straight | 24. RD-1163 Scalpel Handles Suitable for blades |
| 12. RD-1478 Enucleation Scissor, Medium Curved | 25. RD-1901 Sterilizing Tray with Silicon Mat |
| 13. RD-1756 Tissue Forceps, Straight | |

CHALAZION SET

Chalazion Set / 342



RD-1922

1. **RD-1066** Jaeger Lid Plate
2. **RD-1267** Meyerhoefer Chalazion Curette, Size-1
3. **RD-1268** Meyerhoefer Chalazion Curette, Size-2
4. **RD-1269** Meyerhoefer Chalazion Curette, Size-3
5. **RD-1270** Meyerhoefer Chalazion Curette, Size-4
6. **RD-1472** Eye Scissors Curved, Standard
7. **RD-1753** Manhattan Fixation Forceps
8. **RD-1796** Hunt Chalazion Forceps
9. **RD-1798** Desmarres Chalazion Forceps, Medium
10. **RD-1834** Castroviejo Needle Holder Curved, without Lock
11. **RD-1166** Scalpel Handles, 10cm
12. **RD-1901** Sterilizing Tray with Silicon Mat

STRABISMUS SET

Strabismus Set / 343

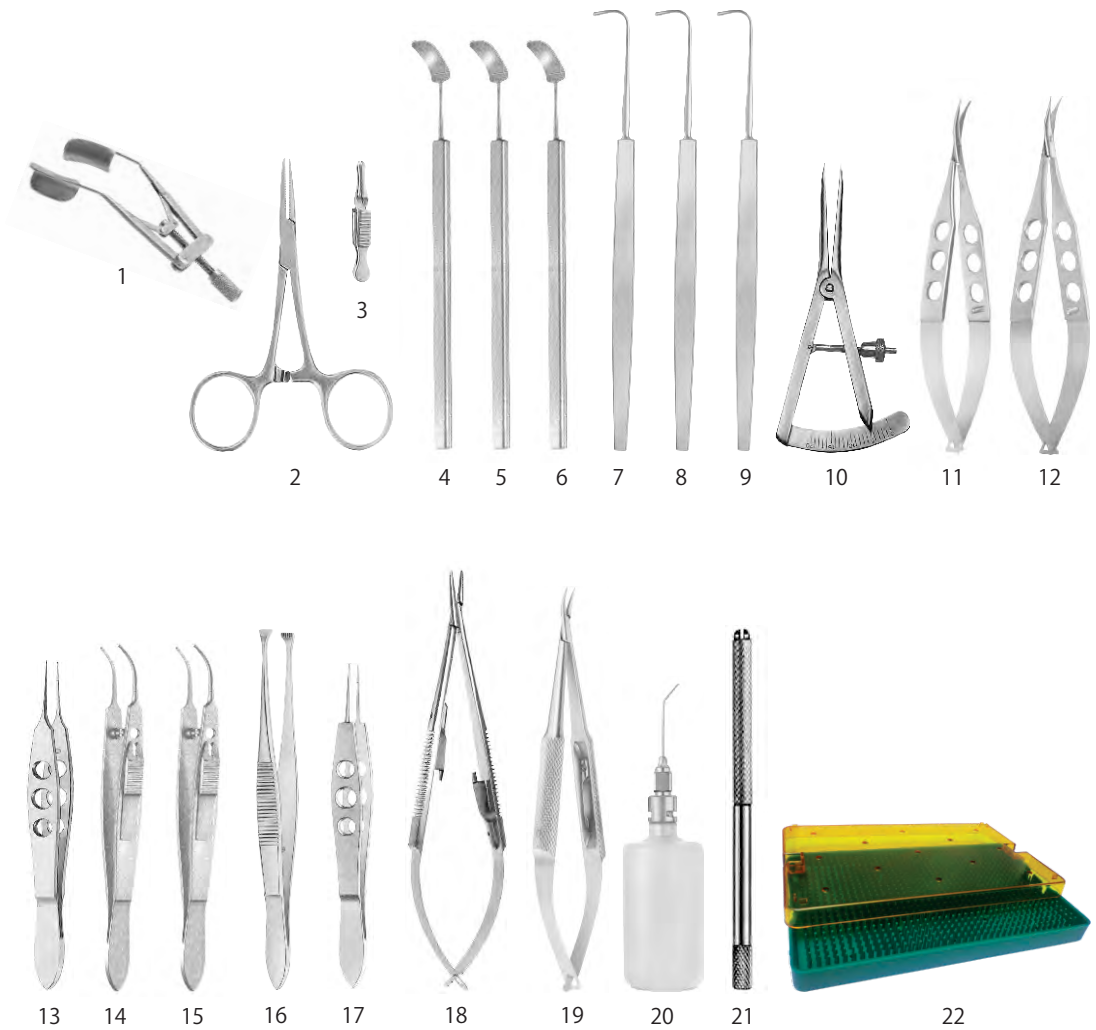

RD-1923

- | | |
|---|--|
| 1. RD-1033 Lieberman Eye Speculum Solid Blades, Adjustable | 12. RD-1488 affe Stitch Scissors, Curved |
| 2. RD-1787 Hartmann Mosquito Forceps, Curved | 13. RD-1668 Bonn Forceps Short Handle, 1x2 Teeth, 0.12mm |
| 3. RD-1784 Serrefine Small, Straight | 14. RD-1725 Moody Fixation Forceps, 1x2 Teeth with Lock Left |
| 4. RD-1094 Helveston Tissue Retractor, 7mm wide | 15. RD-1726 Moody Fixation Forceps, 1x2 Teeth with Lock Right |
| 5. RD-1095 Helveston Tissue Retractor, 9mm wide | 16. RD-1760 Graefe Fixation Forceps |
| 6. RD-1096 Helveston Tissue Retractor, 11mm wide | 17. RD-1691 Harms Tying Forceps, Straight |
| 7. RD-1249 Graefe Muscle Hook Size-1 | 18. RD-1835 Castroviejo Needle Holder, Straight |
| 8. RD-1250 Graefe Muscle Hook Size-2 | 19. RD-1848 Barraquer Needle Holder with Lock |
| 9. RD-1251 Graefe Muscle Hook Size-3 | 20. RD-1602 Bishop-Harmon Anterior Chamber Irrigator |
| 10. RD-1097 Castroviejo Caliper, Straight | 21. RD-1166 Scalpel Handles, 10cm |
| 11. RD-1489 Westcott Tenotomy Scissors, Curved | 22. RD-1901 Sterilizing Tray with Silicon Mat |

LACRIMAL SET

Lacrimal Set / 344

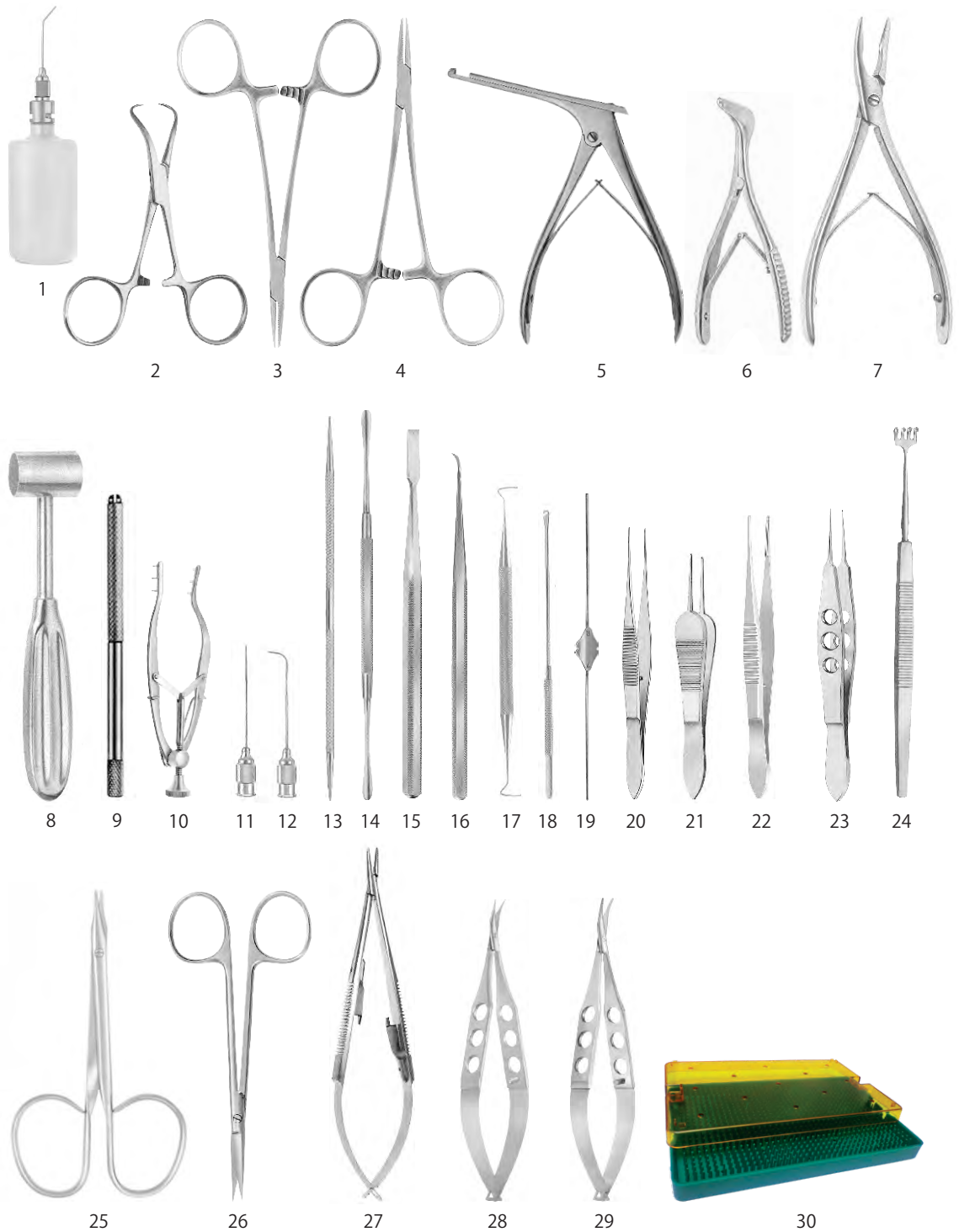

RD-1924

- | | |
|--|---|
| 1. RD-1602 Bishop-Harmon Anterior Chamber Irrigator | 16. RD-1185 Feer Lacrimal Chisel, Curved |
| 2. RD-1782 Backhaus Towel Clamp, 9cm | 17. RD-1134 Pigtail Probe with Suture Holes |
| 3. RD-1788 Halstead Mosquito Forceps, Straight | 18. RD-1137 Crawford Retrieving Hook |
| 4. RD-1789 Halstead Mosquito Forceps, Curved | 19. RD-1127 Bowman Malleable Lacrimal Probe Set of 6 Sizes |
| 5. RD-1204 Kerrison Rongeur Size-1, 3.0mm Wide | 20. RD-1754 Dressing Forceps, Straight |
| 6. RD-1141 Nasal Speculum, Adult | 21. RD-1752 Sauer Fixation Forceps |
| 7. RD-1138 Beyer Rongeur | 22. RD-1764 Bonaccolto Conjunctiva Forceps, Serrated Jaws |
| 8. RD-1143 Mallet Lead Filled | 23. RD-1675 Castroviejo Suturing Forceps, 0.3mm |
| 9. RD-1166 Scalpel Handles, 10cm | 24. RD-1086 Knapp Lacrimal Retractor, Blunt |
| 10. RD-1081 Stevenson Lacrimal Sac Retractor | 25. RD-1475 Stevens Scissor, Curved |
| 11. RD-1622 Lacrimal Cannula, 23 Gauge, Malleable Tip, Straight | 26. RD-1471 Eye Scissors, Straight |
| 12. RD-1623 Lacrimal Cannula, 23 Gauge, Malleable Tip, Curved | 27. RD-1833 Castroviejo Needle Holder, Curved with Lock |
| 13. RD-1133 Castroviejo Lacrimal Dilator, Double-Ended | 28. RD-1488 affe Stitch Scissors, Curved |
| 14. RD-1181 Freer Periosteal Elevator | 29. RD-1508 Tibolt Punctal Scissors |
| 15. RD-1184 West Lacrimal Chisel, Straight | 30. RD-1901 Sterilizing Tray with Silicon Mat |

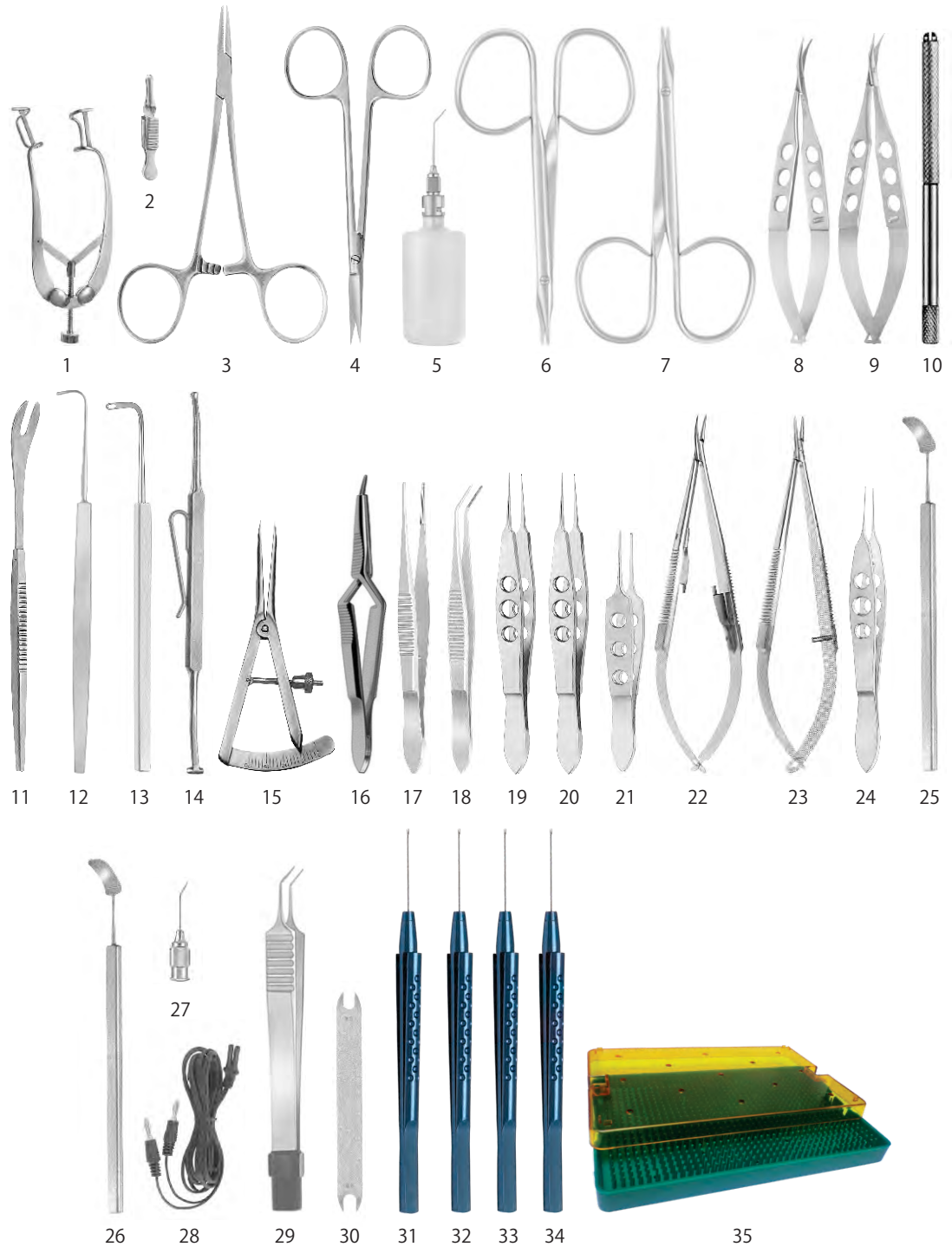

RD-1925

- | | |
|--|--|
| 1. RD-1025 Castroviejo Eye Speculum, Adjustable | 19. RD-1674 Castroviejo Suturing Forceps, 0.12mm |
| 2. RD-1784 Serrefine Small, Straight | 20. RD-1675 Castroviejo Suturing Forceps, 0.3mm |
| 3. RD-1788 Halstead Mosquito Forceps, Straight | 21. RD-1749 Bishop-Harmon Tissue Forceps, Standard |
| 4. RD-1471 Eye Scissors, Straight | 22. RD-1833 Castroviejo Needle Holder Curved, with Lock |
| 5. RD-1602 Bishop-Harmon Anterior Chamber Irrigator Complete | 23. RD-1831 Castroviejo Needle Holder Straight, with Lock |
| 6. RD-1474 Stevens Scissors, Straight | 24. RD-1684 McPherson Tying Forceps, Straight |
| 7. RD-1475 Stevens Scissors, Curved | 25. RD-1094 Helveston Tissue Retractor, 7mm wide |
| 8. RD-1489 Westcott Tenotomy Scissors Blunt tips, Medium blades, Curved | 26. RD-1096 Helveston Tissue Retractor, 11mm wide |
| 9. RD-1488 Jaffe Stitch Scissors Very sharp pointed tips, Medium blades, Curved | 27. RD-1585 Gills Aspirating Cannula, 10mm Tip |
| 10. RD-1166 Scalpel Handles, 10cm | 28. RD-1819 Bipolar Cord Autoclave able |
| 11. RD-1092 Schepens Orbital Retractor | 29. RD-1817 Bipolar Forceps, Blunt tips, Angled |
| 12. RD-1250 Graefe Muscle Hook, Size-2 | 30. RD-1100 Braunstein Caliper 3.5mm & 4mm |
| 13. RD-1247 Gass Retinal Detachment Hook | 31. RD-1527T Vitreo-Retinal Scissors, Curved (R 12mm) ,23 Gauge |
| 14. RD-1065 Schocket Scleral Depressor | 32. RD-1731T Vitreo-Retinal Forceps, Serrated Crocodile Forceps, 23 Gauge |
| 15. RD-1097 Castroviejo Caliper, Straight | 33. RD-1741T Vitreo-Retinal Forceps, Straight and End Gripping Jaws, 23 Gauge |
| 16. RD-1802 Watzke Sleeve Spreading Forceps | 34. RD-1745T Vitreo-Retinal Forceps, ILM Forceps, 23 Gauge |
| 17. RD-1763 Bonaccolto Conjunctiva Forceps | 35. RD-1901 Sterilizing Tray with Silicon Mat |
| 18. RD-1762 Nugent Utility Forceps, Serrated Jaws | |

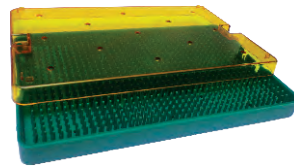
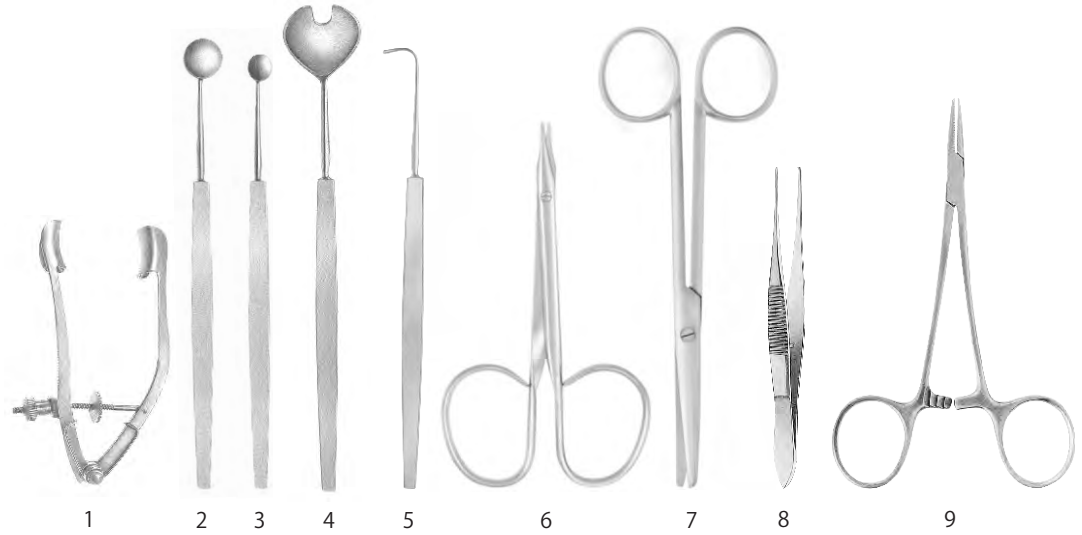

10

RD-1926

-
1. **RD-1032** Lancaster Eye Speculum
 2. **RD-1273** Bunge Evisceration Spoon Large
 3. **RD-1272** Bunge Evisceration Spoon Small
 4. **RD-1274** Wells Enucleation Spoon
 5. **RD-1250** Graefe Muscle Hook, Size-2
 6. **RD-1474** Stevens Scissor, Straight
 7. **RD-1479** Enucleation Scissor, Strong Curve
 8. **RD-1756** Tissue Forceps, Straight
 9. **RD-1789** Halstead Mosquito Forceps, Curved
 10. **RD-1901** Sterilizing Tray with Silicon Mat

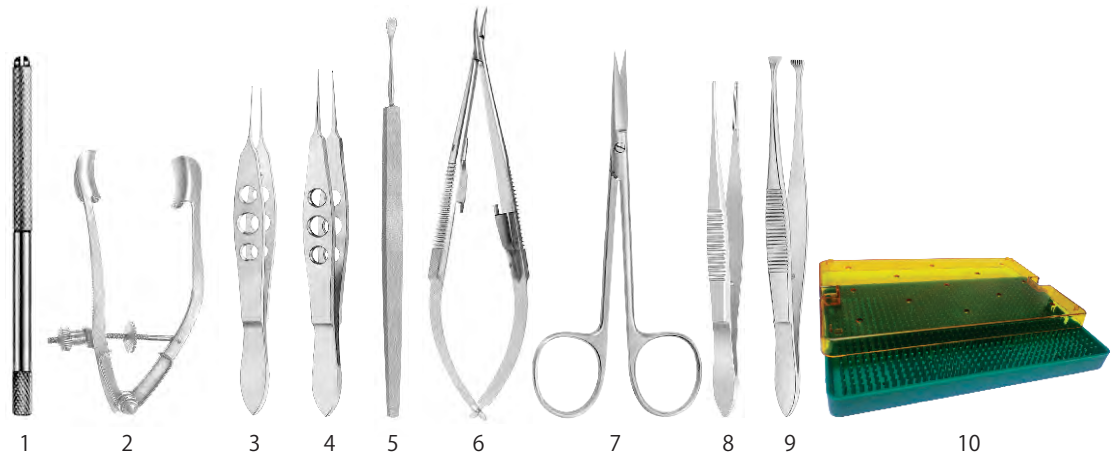

RD-1927

1. **RD-1166** Scalpel Handle, 10cm
2. **RD-1032** Lancaster Eye Speculum
3. **RD-1684** McPherson Tying Forceps, Straight
4. **RD-1674** Castroviejo Suturing Forceps, 0.12mm
5. **RD-1189** Gill Corneal Knife, Straight
6. **RD-1834** Castroviejo Needle Holder Curved, without Lock
7. **RD-1471** Eye Scissors Straight, Standard
8. **RD-1763** Bonaccolto Conjunctiva Forceps, Serrated Jaws
9. **RD-1760** Graefe Fixation Forceps
10. **RD-1901** Sterilizing Tray with Silicon Mat

INDEX

Item #	Page #	Item #	Page #	Item #	Page #	Item #	Page #
RD-1001	1	RD-1065	8	RD-1143	14	RD-1269	23
RD-1002	1	RD-1066	8	RD-1161	15	RD-1270	23
RD-1003	1	RD-1081	9	RD-1161T	15	RD-1271	23
RD-1004	1	RD-1082	9	RD-1162	15	RD-1272	23
RD-1005	2	RD-1083	9	RD-1162T	15	RD-1273	23
RD-1006	2	RD-1084	9	RD-1163	15	RD-1274	23
RD-1007	2	RD-1085	9	RD-1164	15	RD-1281	24
RD-1008	2	RD-1086	10	RD-1165	15	RD-1281T	24
RD-1009	2	RD-1087	10	RD-1166	15	RD-1282	24
RD-1010	2	RD-1088	10	RD-1167	15	RD-1282T	24
RD-1011	2	RD-1089	10	RD-1181	16	RD-1283	24
RD-1012	2	RD-1090	10	RD-1182	16	RD-1283T	24
RD-1013	3	RD-1091	10	RD-1183	16	RD-1284	24
RD-1013T	3	RD-1092	10	RD-1184	16	RD-1284T	24
RD-1014	3	RD-1093	11	RD-1185	16	RD-1285	24
RD-1014T	3	RD-1093T	11	RD-1186	17	RD-1285T	24
RD-1015	3	RD-1094	11	RD-1187	17	RD-1286	24
RD-1015T	3	RD-1094T	11	RD-1188	17	RD-1286T	24
RD-1016	3	RD-1095	11	RD-1189	17	RD-1287	24
RD-1016T	3	RD-1095T	11	RD-1190	17	RD-1287T	24
RD-1017	3	RD-1096	11	RD-1191	17	RD-1288	25
RD-1017T	3	RD-1096T	11	RD-1192	17	RD-1288T	25
RD-1018	3	RD-1097	11	RD-1193	17	RD-1289	25
RD-1018T	3	RD-1097T	11	RD-1194	17	RD-1289T	25
RD-1019	3	RD-1098	11	RD-1195	17	RD-1290	25
RD-1019T	3	RD-1098T	11	RD-1196	17	RD-1290T	25
RD-1020	3	RD-1099	11	RD-1201	18	RD-1291	25
RD-1020T	3	RD-1099T	11	RD-1201T	18	RD-1291T	25
RD-1021	4	RD-1100	11	RD-1202	18	RD-1292	25
RD-1022	4	RD-1100T	11	RD-1203T	18	RD-1292T	25
RD-1023	4	RD-1101	11	RD-1204	19	RD-1293	25
RD-1024	4	RD-1121	12	RD-1205	19	RD-1293T	25
RD-1025	4	RD-1122	12	RD-1206	19	RD-1294	25
RD-1026	4	RD-1123	12	RD-1221	20	RD-1294T	25
RD-1027	5	RD-1124	12	RD-1222	20	RD-1295	25
RD-1028	5	RD-1125	12	RD-1223	20	RD-1295T	25
RD-1029	5	RD-1126	12	RD-1224	20	RD-1296	26
RD-1030	5	RD-1127	12	RD-1225	20	RD-1296T	26
RD-1031	5	RD-1128	12	RD-1226	20	RD-1297	26
RD-1032	5	RD-1128T	12	RD-1227	20	RD-1297T	26
RD-1033	6	RD-1129	12	RD-1241	21	RD-1298	26
RD-1033T	6	RD-1129T	12	RD-1243	21	RD-1298T	26
RD-1034	6	RD-1130	12	RD-1244	21	RD-1299	26
RD-1034T	6	RD-1130T	12	RD-1245	21	RD-1299T	26
RD-1035	6	RD-1131	12	RD-1246	21	RD-1300	26
RD-1035T	6	RD-1131T	12	RD-1247	21	RD-1300T	26
RD-1036	6	RD-1132	12	RD-1248	22	RD-1301	26
RD-1036T	6	RD-1132T	12	RD-1249	22	RD-1301T	26
RD-1037	7	RD-1133	13	RD-1250	22	RD-1302	27
RD-1037T	7	RD-1134	13	RD-1251	22	RD-1302T	27
RD-1038	7	RD-1135	13	RD-1252	22	RD-1303	27
RD-1038T	7	RD-1136	13	RD-1253	22	RD-1303T	27
RD-1039	7	RD-1137	13	RD-1254	22	RD-1304	27
RD-1039T	7	RD-1138	14	RD-1255	22	RD-1304T	27
RD-1061	8	RD-1139	14	RD-1256	22	RD-1305	27
RD-1062	8	RD-1140	14	RD-1266	23	RD-1305T	27
RD-1063	8	RD-1141	14	RD-1267	23	RD-1306	27
RD-1064	8	RD-1142	14	RD-1268	23	RD-1306T	27

INDEX

Item #	Page #	Item #	Page #	Item #	Page #	Item #	Page #
RD-1307	27	RD-1360T	32	RD-1402T	36	RD-1445	41
RD-1307T	27	RD-1361	32	RD-1403	37	RD-1445T	41
RD-1308	27	RD-1361T	32	RD-1403T	37	RD-1446	41
RD-1308T	27	RD-1362	32	RD-1404	37	RD-1446T	41
RD-1309	28	RD-1362T	32	RD-1404T	37	RD-1447T	42
RD-1309T	28	RD-1363	32	RD-1405	37	RD-1448	42
RD-1310	28	RD-1363T	32	RD-1405T	37	RD-1448T	42
RD-1310T	28	RD-1364	32	RD-1406	37	RD-1449	42
RD-1311	28	RD-1364T	32	RD-1406T	37	RD-1449T	42
RD-1311T	28	RD-1365	33	RD-1407	37	RD-1450	42
RD-1312	28	RD-1365T	33	RD-1407T	37	RD-1450T	42
RD-1312T	28	RD-1366	33	RD-1408	37	RD-1451	42
RD-1313	28	RD-1366T	33	RD-1408T	37	RD-1451T	42
RD-1313T	28	RD-1367	33	RD-1409	37	RD-1452	42
RD-1314	28	RD-1367T	33	RD-1409T	37	RD-1452T	42
RD-1314T	28	RD-1368	33	RD-1410T	38	RD-1453	42
RD-1315	28	RD-1368T	33	RD-1411T	38	RD-1453T	42
RD-1315T	28	RD-1369	33	RD-1412T	38	RD-1454	42
RD-1316	28	RD-1369T	33	RD-1413T	38	RD-1454T	42
RD-1316T	28	RD-1370	34	RD-1414T	38	RD-1455	42
RD-1341	29	RD-1370T	34	RD-1415T	38	RD-1455T	42
RD-1341T	29	RD-1371	34	RD-1416T	38	RD-1456	42
RD-1342	29	RD-1371T	34	RD-1417T	38	RD-1456T	42
RD-1342T	29	RD-1372	34	RD-1418T	38	RD-1457	42
RD-1343	29	RD-1372T	34	RD-1419T	38	RD-1457T	42
RD-1343T	29	RD-1373	34	RD-1420T	38	RD-1458	42
RD-1344	29	RD-1373T	34	RD-1421T	38	RD-1458T	42
RD-1344T	29	RD-1374	34	RD-1422T	39	RD-1459	42
RD-1345	29	RD-1374T	34	RD-1423T	39	RD-1459T	42
RD-1345T	29	RD-1375	34	RD-1424T	39	RD-1460	42
RD-1346	29	RD-1375T	34	RD-1431	40	RD-1460T	42
RD-1346T	29	RD-1376	34	RD-1431T	40	RD-1461	42
RD-1347	30	RD-1376T	34	RD-1432	40	RD-1461T	42
RD-1347T	30	RD-1377	34	RD-1432T	40	RD-1462	42
RD-1348	30	RD-1377T	34	RD-1433	40	RD-1462T	42
RD-1348T	30	RD-1391	35	RD-1433T	40	RD-1463	42
RD-1349	30	RD-1391T	35	RD-1434	40	RD-1463T	42
RD-1349T	30	RD-1392	35	RD-1434T	40	RD-1464	42
RD-1350	30	RD-1392T	35	RD-1435	40	RD-1464T	42
RD-1350T	30	RD-1393	35	RD-1435T	40	RD-1465	42
RD-1351T	30	RD-1393T	35	RD-1436	40	RD-1465T	42
RD-1352T	30	RD-1394	35	RD-1436T	40	RD-1469	43
RD-1353	31	RD-1394T	35	RD-1437	40	RD-1470	43
RD-1353T	31	RD-1395	35	RD-1437T	40	RD-1471	43
RD-1354	31	RD-1395T	35	RD-1438	40	RD-1472	43
RD-1354T	31	RD-1396	35	RD-1438T	40	RD-1473	43
RD-1355	31	RD-1396T	35	RD-1439	41	RD-1474	43
RD-1355T	31	RD-1397	35	RD-1439T	41	RD-1475	43
RD-1356	31	RD-1397T	35	RD-1440	41	RD-1476	44
RD-1356T	31	RD-1398	36	RD-1440T	41	RD-1477	44
RD-1357	31	RD-1398T	36	RD-1441	41	RD-1478	44
RD-1357T	31	RD-1399	36	RD-1441T	41	RD-1479	44
RD-1358	31	RD-1399T	36	RD-1442	41	RD-1480	45
RD-1358T	31	RD-1400	36	RD-1442T	41	RD-1481	45
RD-1359	32	RD-1400T	36	RD-1443	41	RD-1482	45
RD-1359T	32	RD-1401	36	RD-1443T	41	RD-1483	45
RD-1360	32	RD-1401T	36	RD-1444	41	RD-1484	45
		RD-1402	36	RD-1444T	41	RD-1485T	46

INDEX

Item #	Page #	Item #	Page #	Item #	Page #	Item #	Page #
RD-1486T	46	RD-1530T	50	RD-1609	55	RD-1674	60
RD-1487	46	RD-1531T	50	RD-1610	55	RD-1674T	60
RD-1488	46	RD-1532T	50	RD-1611	55	RD-1675	60
RD-1489	46	RD-1533T	50	RD-1612	55	RD-1675T	60
RD-1490	46	RD-1534T	50	RD-1613	55	RD-1676	60
RD-1491	46	RD-1535T	50	RD-1614	55	RD-1676T	60
RD-1492	47	RD-1536T	50	RD-1615	56	RD-1677	60
RD-1493	47	RD-1537T	50	RD-1616	56	RD-1677T	60
RD-1494	47	RD-1538T	50	RD-1617	56	RD-1678	60
RD-1495	47	RD-1560	51	RD-1618	56	RD-1678T	60
RD-1496	47	RD-1561	51	RD-1619	56	RD-1679	60
RD-1497	47	RD-1562	51	RD-1620	56	RD-1679T	60
RD-1498	47	RD-1563	51	RD-1621	56	RD-1680	60
RD-1499	47	RD-1564	51	RD-1622	56	RD-1680T	60
RD-1500	47	RD-1565	51	RD-1623	56	RD-1681	61
RD-1501	47	RD-1566	51	RD-1624	57	RD-1681T	61
RD-1502	48	RD-1567	51	RD-1625	57	RD-1682	61
RD-1503	48	RD-1568	51	RD-1626	57	RD-1682T	61
RD-1504	48	RD-1569	52	RD-1627	57	RD-1683	61
RD-1505	48	RD-1570	52	RD-1628	57	RD-1683T	61
RD-1506	48	RD-1571	52	RD-1629	57	RD-1684	61
RD-1507	48	RD-1572	52	RD-1641T	58	RD-1684T	61
RD-1508	48	RD-1573	52	RD-1642T	58	RD-1685	61
RD-1509	48	RD-1574	52	RD-1643T	58	RD-1685T	61
RD-1510	49	RD-1575	52	RD-1644T	58	RD-1686	61
RD-1510T	49	RD-1576	52	RD-1645T	58	RD-1686T	61
RD-1511	49	RD-1577	52	RD-1646T	58	RD-1687	61
RD-1511T	49	RD-1578	52	RD-1647T	58	RD-1687T	61
RD-1512	49	RD-1579	52	RD-1648T	58	RD-1688	62
RD-1512T	49	RD-1580	52	RD-1649T	58	RD-1688T	62
RD-1513	49	RD-1581	52	RD-1650T	58	RD-1689	62
RD-1513T	49	RD-1582	53	RD-1651T	58	RD-1689T	62
RD-1514	49	RD-1583	53	RD-1661	59	RD-1690	62
RD-1514T	49	RD-1584	53	RD-1661T	59	RD-1690T	62
RD-1515	49	RD-1585	53	RD-1662	59	RD-1691	62
RD-1515T	49	RD-1586	53	RD-1662T	59	RD-1691T	62
RD-1516	49	RD-1587	53	RD-1663	59	RD-1692	62
RD-1516T	49	RD-1588	53	RD-1663T	59	RD-1692T	62
RD-1517	49	RD-1589	53	RD-1664	59	RD-1693	62
RD-1517T	49	RD-1590	53	RD-1664T	59	RD-1693T	62
RD-1518	49	RD-1591	53	RD-1665	59	RD-1694	62
RD-1518T	49	RD-1592	54	RD-1665T	59	RD-1694T	62
RD-1519	49	RD-1593	54	RD-1666	59	RD-1695	62
RD-1519T	49	RD-1594	54	RD-1666T	59	RD-1695T	62
RD-1520	49	RD-1595	54	RD-1667	59	RD-1696	63
RD-1520T	49	RD-1596	54	RD-1667T	59	RD-1696T	63
RD-1521	49	RD-1597	54	RD-1668	60	RD-1697	63
RD-1521T	49	RD-1598	54	RD-1668T	60	RD-1697T	63
RD-1522	49	RD-1599	54	RD-1669	60	RD-1698	63
RD-1522T	49	RD-1600	54	RD-1669T	60	RD-1698T	63
RD-1523	49	RD-1601	54	RD-1670	60	RD-1699	63
RD-1523T	49	RD-1602	54	RD-1670T	60	RD-1699T	63
RD-1524T	50	RD-1603	54	RD-1671	60	RD-1700	63
RD-1525T	50	RD-1604	54	RD-1671T	60	RD-1700T	63
RD-1526T	50	RD-1605	54	RD-1672	60	RD-1701T	64
RD-1527T	50	RD-1606	54	RD-1672T	60	RD-1702T	64
RD-1528T	50	RD-1607	55	RD-1673	60	RD-1703T	64
RD-1529T	50	RD-1608	55	RD-1673T	60	RD-1704	64

INDEX

Item #	Page #	Item #	Page #	Item #	Page #	Item #	Page #
RD-1705	65	RD-1749	70	RD-1795	77	RD-1842T	83
RD-1705T	65	RD-1749T	70	RD-1796	77	RD-1843	83
RD-1706	65	RD-1750	70	RD-1797	77	RD-1843T	83
RD-1706T	65	RD-1750T	70	RD-1798	77	RD-1844	83
RD-1707	65	RD-1751	70	RD-1799	77	RD-1844T	83
RD-1707T	65	RD-1751T	70	RD-1800	77	RD-1845	83
RD-1708	65	RD-1752	70	RD-1801	78	RD-1845T	83
RD-1708T	65	RD-1752T	70	RD-1802	78	RD-1846	83
RD-1709	65	RD-1753	70	RD-1803T	78	RD-1846T	83
RD-1709T	65	RD-1753T	70	RD-1804T	78	RD-1847	83
RD-1710	65	RD-1754	70	RD-1805T	78	RD-1847T	83
RD-1710T	65	RD-1755	70	RD-1806T	79	RD-1848	83
RD-1711	65	RD-1756	71	RD-1807T	79	RD-1848T	83
RD-1711T	65	RD-1757	71	RD-1808	79	RD-1849	83
RD-1712T	65	RD-1758	71	RD-1808T	79	RD-1849T	83
RD-1713T	65	RD-1759	71	RD-1809	79	RD-1850	83
RD-1714T	66	RD-1760	71	RD-1809T	79	RD-1850T	83
RD-1715T	66	RD-1761	72	RD-1810	79	RD-1851	83
RD-1716T	66	RD-1762	72	RD-1810T	79	RD-1851T	83
RD-1717T	66	RD-1763	72	RD-1811	79	RD-1852	84
RD-1718T	67	RD-1764	72	RD-1811T	79	RD-1852T	84
RD-1719T	67	RD-1765	72	RD-1812	79	RD-1853	84
RD-1720T	67	RD-1766	72	RD-1812T	79	RD-1853T	84
RD-1721	67	RD-1767	72	RD-1813	80	RD-1854	84
RD-1722	68	RD-1768	72	RD-1813T	80	RD-1854T	84
RD-1722T	68	RD-1769	72	RD-1814	80	RD-1855	84
RD-1723	68	RD-1770	73	RD-1814T	80	RD-1855T	84
RD-1723T	68	RD-1771	73	RD-1815	80	RD-1856T	84
RD-1724	68	RD-1772	73	RD-1815T	80	RD-1857T	84
RD-1724T	68	RD-1773	73	RD-1816	80	RD-1858	84
RD-1725	68	RD-1774	73	RD-1817	81	RD-1858T	84
RD-1725T	68	RD-1774T	73	RD-1818	81	RD-1859	84
RD-1726	68	RD-1775	73	RD-1819	81	RD-1859T	84
RD-1726T	68	RD-1775T	73	RD-1820	81	RD-1860	84
RD-1727	68	RD-1776	73	RD-1820T	81	RD-1860T	84
RD-1727T	68	RD-1776T	73	RD-1821	81	RD-1861	84
RD-1728T	69	RD-1777	74	RD-1821T	81	RD-1861T	84
RD-1729T	69	RD-1777T	74	RD-1822	81	RD-1862	84
RD-1730T	69	RD-1778	74	RD-1822T	81	RD-1862T	84
RD-1731T	69	RD-1778T	74	RD-1823	81	RD-1863	84
RD-1732T	69	RD-1779	74	RD-1823T	81	RD-1863T	84
RD-1733T	69	RD-1779T	74	RD-1824	81	RD-1881	85
RD-1734T	69	RD-1780	74	RD-1824T	81	RD-1882	85
RD-1735T	69	RD-1780T	74	RD-1831	82	RD-1883	85
RD-1736T	69	RD-1781	74	RD-1832	82	RD-1884	85
RD-1737T	69	RD-1782	75	RD-1833	82	RD-1885	85
RD-1738T	69	RD-1783	75	RD-1834	82	RD-1886	85
RD-1739T	69	RD-1784	75	RD-1835	82	RD-1887	85
RD-1740T	69	RD-1785	75	RD-1836	82	RD-1888	85
RD-1741T	69	RD-1786	75	RD-1837	82	RD-1889	85
RD-1742T	69	RD-1787	75	RD-1838	82	RD-1890	85
RD-1743T	69	RD-1788	76	RD-1839	83	RD-1891	85
RD-1744T	69	RD-1789	76	RD-1839T	83	RD-1892	85
RD-1745T	69	RD-1790	76	RD-1840	83	RD-1893	85
RD-1746T	69	RD-1791	76	RD-1840T	83	RD-1894	85
RD-1747T	69	RD-1792	76	RD-1841	83	RD-1895	85
RD-1748	70	RD-1793	76	RD-1841T	83	RD-1896	85
RD-1748T	70	RD-1794	77	RD-1842	83	RD-1900	86
						RD-1901	86
						RD-1902	86

Article	Page #	Article	Page #
3D Diamond Knives	38	Castrviejo Needleholder	82
Adson	72	Catroviejo Eye Speculum	4
Agarwal Karate Phaco Chopper	33	Chang Hydrodissection Cannula	56
Agricola Lacrimal Sac Retractor	9	Chang MicroFinger Chopper	33
Akahoshi Micro Prechopper Forceps	67	Chang Phaco Chopper	32
Alio MIC-S Scissors	50	Chang-Seibel Phaco Chopper	31
Anis Cortex Aspirating Cannula	54	Cilia Forceps	73
Anis Irrigating Cannula	53	Citelli Rongeur	19
Anis Needleholder	84	Clayman Lens Holding Forceps	81
Anis Radial Marker	41	Clayman Nucleus Rotator	26
Baby Jones Towel Clamp	74	Colibri Forceps	59
Backhaus Towel Clamp	75	Cook Eye Speculum	5
Barraquer Cilia Forceps	73	Cornea Trephine Blades & Handles	85
Barraquer Heavy Wire Speculum	1	Corneal Dissector	17
Barraquer Iris Scissors	45	Corneal Suturing Forceps	59
Barraquer Iris Spatula	20	Crawford Retrieving Hook	13
Barraquer Needleholder	83/84	Culler iris Spatula	20
Barraquer Speculum with Solid Blade	1	Culler Lens Spoon	23
Barraquer Wire Speculum	1	Dahan-Blumenthal Anterior Chamber Maintainer	57
Bayonet Dressing Forceps	72	DALK Air Cannula	51
Bechert Nucleus Rotator	26	DALK Coneal Dissector	35
Benedetto IntraLase Spatula	35	DALK Lamellar Dissector	17
Berchert Forceps	61	DALK Micro Scissors Left + Right Set	48
Berke Ptosis Forceps	76	De La O Aspirating Cannula	54
Beyer Rongeur	14	Desmarres Chalazion Forceps	77
Binder IntraLase Elevator	36	Desmarres Lid Retractor	10
Bipolar Cord	80	Diamond Knife with Glaucoma Surgery	39
Bipolar Forceps Jewels Type	80	Diamond Knife with LRI Surgery	39
Bipolar Forceps McPherson Type	80	Diamond Knives	38
Birks Needleholder	83	Dodick Nucleus Cracker	65
Bishop Irrigation-Aspirating Cannula	52	Dodick-Kammann Nucleus Chopper	34
Bishop-Harmon Anterior Chamber Irrigator	54	Double-X Speculum	4
Bishop-Harmon Dressing Forceps	70	Double-X Speculum	4
Bishop-Harmon Tissue Forceps	70	Dressing Forceps	70
Bonaccolto Conjunctiva Forceps	72	Drews Needleholder	83
Bonaccolto Utility & Siitter Forceps	62	Drysdale Nucleus Manipulator	28
Bonn Forceps	60	Elsching Sclera' Forceps	71
Bonn Micro Iris Hook	24	Elschnig Cyclodialysis Spatula	20
Bores Axis Marker	41	Endothelial Stripper	37
Bowman Malleable Lacrimal Probe	12	Enucleation Scissors	44
Braunstein Caliper	11	Ernest-McDonald IOL Inserting Forceps	79
Brierty Cahmber Maintainer	57	Escaf Nucleus Divider	34
Brierty Nucleus Splitter	34	Escaf Nucleus Manipulator	27
Brinkhorst Irrigation Cannula	51	Extra Fine Needle Holder	84
Bunge Evisceration Spoon	23	Eye Scissors	43
Buratto Bi-Manual Aspiration Handpiece	58	Faulkner Lens Holding Forceps	79
Buratto Bi-Manual Irrigation Handpiece	58	Feaster Hydrodissection Cannula	56
Buratto Lasik Flap Forceps	68	Fechtner Conjunctival Forceps	68
Buratto LASIK Irrigation Cannula	55	Feer Lacrimal Chisel	16
Camellin Style LASEK Alcohol Well	41	Fenzl Lens Manipulating Hook	25
Capsule Polishing Curette	52	Fine Stitch Scissors	47
Capsulotomy Scissors	49	Fine-Thornton Swivel Fixation Ring	40
Castroviejo Blade Breaker & Holder	15	Fixation Hook	22
Castroviejo Caliper	11	Flieringa Scleral Fixation Ring	8
Castroviejo Corneoscleral Scissors	48	Foreign Body Forceps	62
Castroviejo Keratoplasty Scissors	45	Foreign Body Spud	17
Castroviejo Lacrimal Dilator	13	Frankel Infant Lid Speculum	2
Castroviejo Suturing Forceps	60	Freer Periosteal Elevator	16
Castroviejo Synechia Sptula	21	Friedman-Koch Universal Chopper & Spatula	30
Castroviejo Universal Corneal Scissors	47	Fukasaku "Hockey" Knife	17
Castroviejo-Colibri Forceps	59		

Article	Page #	Article	Page #
Fukasaku LASIK Spatula	36	Katzen I-ASIK Flap "Unzipper"	37
Fukasaku Micro Trabeculectomy Punch	18	Katzin Corneal Transplant Scissors	47
Fukasaku-Lieberman Phaco Spatula	28	Kellan Hydrodissection Cannula	55
Gaskin Fragment Forceps	62	Kellen Capsulorhexis Marker	42
Gass Corneoscleral Punch	18	Kelly Membrane Punch	18
Gass Retinal detachment Hook	21	Kelman-McPherson Forceps	60
Giannetti MICS Capsulorhexis Forceps	63	Kelman-McPherson Forceps	61
Gill Corneal Knife	17	Kelman-McPherson Lens Holding Forceps	79
Gills Aspirating Cannula	53	Kerrison Rongeur	19
Gills-Colibri Forceps	59	Kirby Lens Loop	21
Gimbel Nucleus Spatula	35	Knapp Lacrimal Retractor	10
Girnel Stabilizing Ring	40	Knapp Strabismus Scissors	44
Girard Synechia Spatula	35	Knolle Nucleus Spatula	27
Graefe Fixation Forceps	71	Knolle-Pearce Irrigating Vectis	53
Graefe Muscle Hook	22	Koch Nucleus Chopper	34
Graether Collar Button Micro Iris Retractor	27	Koch-Nagahara Spatula & Chopper	29
Grayson Nucleus Manipulator	28	Kraff Capsule Tag Forceps	63
Green Fixation Forceps	73	Kraff Eye Speculum	6
Green Muscle Hook	22	Kraff Nasal LASIK Speculum	6
Guell LASIK Irrigation Cannula	55	Kratz Lens Holding Forceps	81
Guimaraes LASIK Spatula	36	Kratz-Barraquer Heavy Wire Speculum with Open Blade	2
Halstead	76	Kuglen Iris Hook & Lens Manipulator	25
Harms Trabeculectomy Probe	13	Lacrimal Cannula	56
Harms Tying Forceps	62	Lambert Chalazion Forceps	77
Harms-Colibri Forceps	59	Lancaster Eye Speculum	5
Harrison Butler Lacrimal Cannula	51	Langs Lacrimal Cannula	51
Hersh IntraLase Flap Spatula	36	LASIK Double Arm Cannula	55
Hartmann Mosquito Forceps	75	Lens Cutting & Holding Forceps	78
Heelveston Tissue Retractor	11	Lens Cutting Forceps	78
Hestin Infusion Cannula	57	Lens Holding Forceps	78
Hirshman Iris Hook	24	Lester IOL Manipulator	26
Hoffer Corneal Optical Zone Markers	42	Lewicky Chamber Maintainer	57
Hoffer-McPherson Forceps	60	Lewicky IOL Manipulating Hook	24
Hofmann-Thornton Globe Fixation Ring	40	Lewis Lens Loop	21
Hoskin Corneal Forceps	61	Lieberman Style Wire Speculum	3
Hunt Chalazion Forceps	77	Lieberman Aspirating Speculum	7
Hwang Phaco Chopper	33	Lieberman Eye Speculum	6
ICL Lens Cartridge Loading Forceps	78	Lieberman MicroFinger & Spatula	28
Inamura Capsulorhexis Forceps	65/66	Lieberman Temporal Approach Speculum	3
Inamura Round Handle Capsulorhexis Forceps for Scleral Tunnel Incision	66	Livernois Pick-up & Holding Forceps	79
Infant Lacrimal Dilator	12	Lu-Mendez LRI Guide & Fixation Rings	40
Infusion Cannula	57	Machat-Buratto Aspirating LASIK Speculum	7
Intra-Op Toric Axis Marker	42	Maddox LASIK Spatula	37
iris Scissors	43/46	Mallet Lead Filled	14
Irrigating-Aspirating Canula	53	Maloney Intra-operative Keratometer	42
Jaeger Lid Plate	8	Maltzman-Fenzl Lens Manipulating Hook	25
Jaffe IOL Spatula	26	Manhattan Fixation Forceps	70
Jaffe Lens Manipulating Hook	24	Masket Capsulorhexis Forceps	63
Jaffe Lid Retractor	9	Masket Phaco Spatula	32
Jaffe Stitch Scissors	46	MCDonald Optic Zone Marker	41
Jaffe Utility Forceps	62	McIntyre Anterior Chamber Cannula	52
Jaffe-Blaydes Lens Holding Forceps	81	McIntyre Lacrimal Cannula	56
Jaffe-Maltzman Lens Manipulating Hook	25	McIntyre Wire Speculum	2
Jameson Muscle Forceps	76	McIntyre-Binkhorst Cannula	54
Jameson Muscle Hook	22	McPerson Iris Spatula	20
Jensen Posterior Capsule Polisher	52	McPherson Corneal Forceps	60
Jewelers Forceps	73/74	McPherson Needleholder	84
Joseph Periosteal Elevator	14	Mc-Pherson Tying Forceps	61
Kalt Needleholder	82	McPherson-Westcott Conjunctiva' Scissors	46
Kammann Prechopper	29	Mendez Degree Gauge	40

Article	Page #	Article	Page #
Mendez Multi-Purpose LASIK Forceps	63	Stevens Tenotomy Scissors	44
Metzenbaum Dissecting Scissors	44	Stevenson Lacrimal Sac Retractor	9
Meyerhoefer Chalazion Curette	23	Stitch Scissors	43/44
Micro Incision Capsulorhexis Forceps	65	Sud & Gouge	17
Micro Lens Cutter	78	Tennant Nucleus Manipulator	29
MICS Phaco Pre-Chopper	31	Tennant Tying Forceps	62
Milder Phaco Chopper	32	Terry Micro Corneal Scissors	48
Minardi Phaco Chopper	33	Thorlakson Z-LASIK Flap Lifter	37
Moody Fixation Forceps	68	Thornton Globe Fixation Ring	40
Moran LASIK Enhancement Spatula	36	Tibolt Punctal Scissors	48
Morrison Aspirating Cannula	54	Tissue Forceps	71
Muldoon Lacrimal Dilator	12	Tooke Corneal Knife	17
Murdoch Eye Speculum	5	Toric Marker	41
Nagahara Bi-Manual Irrigating Carate Chopper	30	Troutman Blade Breaker & Holder	15
Nagahara Bi-Manual Irrigating Chopper	30	Troutman Needleholder	83
Nagahara Phaco Chopper	29	Troutman-Castroviejo Corneoscleral Scissors	47
Nasal Speculum	14	Utrata Capsulorhexis Forceps	63/64/65
Neuhann Nucleus Divider	34	Vannas Capsulotomy Scissors	49
Neyyas Wire Speculum	2	Vitreo-Retinal Forceps	69
Nordan Capsule Elevator	30	Vitreo-Retinal Scissors	50
Noyes Scissors	45	Walton Conjunctiva Retractor	11
Nucleus Hydrodissection Cannula	55	Warren Cnine Phaco Chopper	33
Nugent Utility Forceps	68	Watxke Sleeve Spreading Forceps	77
Obstbaum Synechia Spatula	35	Wells Enucleation Spoon	23
Olson Phaco Chopper	30	West Lacrimal Chisel	16
Osher Neuman Corneal Marker	42	Westcott Tenotomy Scissors	45/46
Paddle Prechopper Forceps	67	Westcott Type Scissors	46
Phaco Chopper	31	Wheeier Double Ended Spatula	20
Pierse-Colibri Corneal Forceps	59	Wilbrandt-Brinkhorst Cannula	54
Pigtail Probe	13	Wilder Lacrimal Dilator	12
Ptosis Lid Clamp	77	Wire Speculum	2
Remky Superior Rectus Forceps	71	Wright Fascia Needle	11
Rentsch IOL Manipulating & Iris Hook	25		
Rich Corneal Transplant Scissors	48		
Rollet Rugine	16		
Rosen Phaco Splitter	30		
Rowen Combination I-ASIK Spatula	37		
Rycroft Air Injection Cannula	51		
Sauer Fixation Forceps	70		
Scalpel Handles	15		
Schepens Scleral Depressor	8		
Schiotz Tonometer	85		
Schocket Sclera' Depressor	8		
Schott Eye Speculum	4		
Serrefine Small	75		
Shepard Lens Holding Forceps	81		
Silcocks Needleholder	82		
Simcoe Cortex Extractor	53		
Simcoe Irrigating Lens Nucleus Loop	56		
Simcoe Irrigation-Aspirating Cannula	52		
Sinskey II IOL Manipulating Hook	24		
Sinskey Lens Holding Forceps	81		
Slade Aspirating LASIK Speculum	7		
Slade LASIK Speculum	6		
Snellen Entropion Forceps	77		
Spaleck Soft IOL Inserting Forceps	80		
Stallard Dissector	16		
Step Diamond Knife	39		
Sterilizing Tray	86		
Stern- Conjunctiva Fixation Forceps	68		
Stevens Tenotomy Hook	22		